

ZORSOL

MADE IN ITALY



CATALOGO GENERALE | GENERAL CATALOGUE

2024



ZORSOL

www.zorsol.com



INDICE

INDEX

<i>REFRIGERAZIONE / REFRIGERATION</i>	4
<i>VALVOLE / VALVES</i>	9
<i>MANIGLIE / HANDLES</i>	11
<i>CROCI / CROSSES</i>	23
<i>CROCIFISSI / CRUCIFIXES</i>	40
<i>CRISTI / CHRIST BODIES</i>	67
<i>FINITURA COFANI / COFFIN FINISH</i>	72
<i>TARGHE / PLATES</i>	91
<i>URNE / URNS</i>	98
<i>ACCESSORI PER URNE / URNS ACCESSORIES</i>	112
<i>PRODOTTI TECNICI / TECHNICAL PRODUCTS</i>	114



AZIENDA

Zorsol dal 1943 è leader nel settore funerario. Opera sia sul mercato italiano che estero con una vasta gamma di prodotti che spaziano dagli accessori per cofani funebri, alle valvole di depurazione, ai sistemi refrigeranti ed alle piastre. L'attività di ricerca e sviluppo relativa ai nuovi prodotti ed alle personalizzazioni è effettuata internamente.

L'azienda infatti offre un servizio completo che comprende anche la progettazione e realizzazione degli articoli secondo le richieste dei clienti. Un'importanza fondamentale rivestono anche la funzionalità e l'efficienza del prodotto finito.

L'attenzione ai dettagli e alla qualità della lavorazione sono garantite da un accurato "controllo qualità" interno. Altri punti di forza dell'azienda sono la puntualità nelle spedizioni e l'assistenza tecnica e commerciale. Tutti questi importanti aspetti fanno di Zorsol il partner ideale in grado di rispondere al meglio alle diverse esigenze.

COMPANY

Since 1943 Zorsol has been a leader in the death care industry. It operates in both Italian and foreign markets with a wide range of products ranging from accessories for coffins to depurating valves, refrigeration systems and plates. Research and development of new products as well as customisation are 100% in-company processes.

In fact, the company offers a comprehensive service that includes the design and realisation of the items according to our customers' needs. Great importance is also given to the functionality and efficiency of the final product.

Care for details and quality manufacturing are guaranteed by our thorough internal quality control. On-time delivery and technical and business support are other strengths the company is proud of. All these key factors make Zorsol the ideal partner who can best meet each and every need.

REFRIGERAZIONE

REFRIGERATION

Zorsol da oltre trent'anni produce sistemi refrigeranti per la conservazione temporanea della salma e, grazie a questa pluriennale esperienza acquisita, propone oggi la massima espressione del made in Italy. Il sistema è costituito da un'unità refrigerante e da una piastra collegata ad esso mediante tubazioni flessibili. La piastra viene posizionata sotto la salma e scollegata dall'unità refrigerante prima della chiusura del cofano.

Zorsol has been producing refrigeration systems for over 30 years for the temporary preservation of the corpse. Thanks to its acquired multiannual experience ZORSOL is proposing today the best expression of our "made in Italy". The system consists of a refrigeration unit and a plate connected to it by means of flexible pipes. The cooling plate is placed under the corpse and shall be disconnected from the refrigerating unit before the closing of the coffin.

ZORSOL



CRIO *evo*

l'evoluzione

cod.FR6741

L'unico sistema refrigerante che rispetta l'ambiente
l'unico dotato di telecomando a distanza



Crio Evo rappresenta la quarta generazione di sistemi refrigeranti prodotta da Zorsol, nato dall'esigenza di fornire un servizio di qualità assoluta per i professionisti del settore. L'attenzione all'ambiente è garantita dall'adozione di gas refrigerante fluorurato di ultima generazione che è attualmente la miglior risposta ad un mercato sempre più esigente e rispettoso dell'ecosistema.

Peso	24,5 Kg
Alimentazione	230V - 50 Hz
Circuito comando	24V
Potenza	0.55 KW
Assorbimento	2.4 A
Classe climatica	N
Tipo refrigerante	HFO1234ze
Rumorosità	dB/A: 48 [≤ 70 dB] / dB/C: 57 [≤ 57 dB]

CRIO *evo*

l'evoluzione

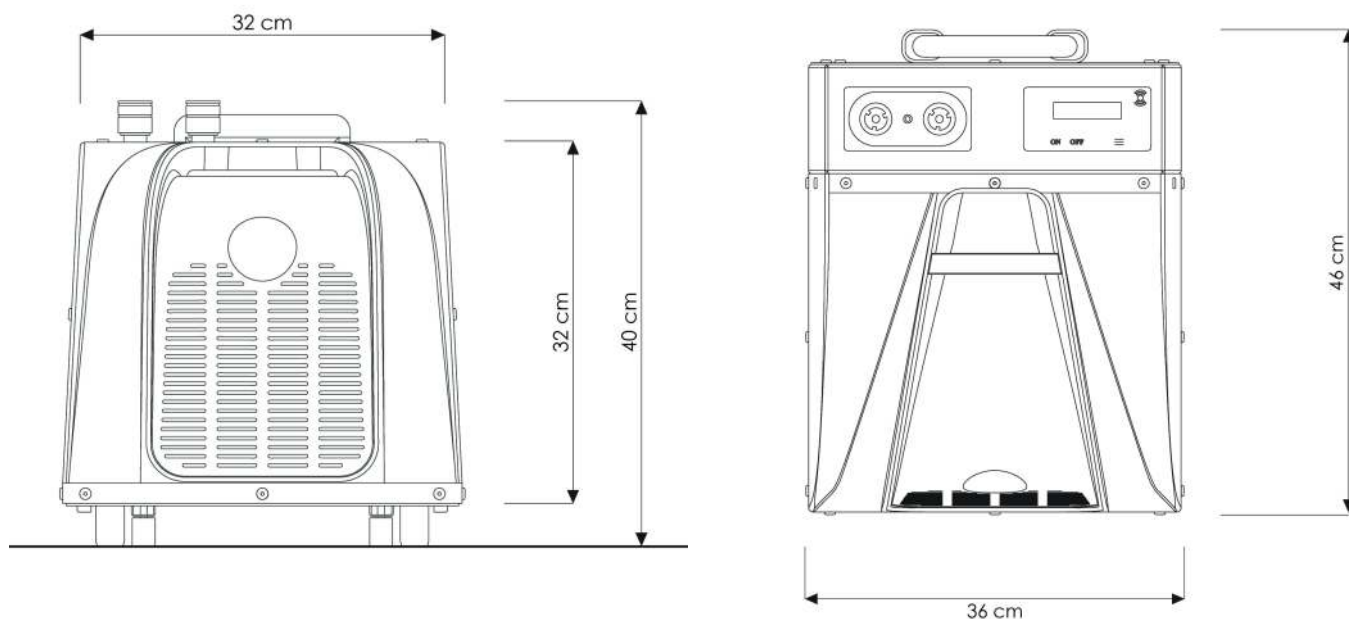

Design moderno, compatto e discreto. Munito di una centralina elettronica che ne permette il controllo ed il monitoraggio anche a distanza con dispositivi mobili, attraverso messaggi SMS.



Display LCD per un pratico utilizzo che consente (inoltre) di monitorare l'efficienza in tempo reale, grazie alla visualizzazione della temperatura di raffreddamento.



Compressore di nuova generazione e scocca con prese d'aria, (anche) sui lati, per una maggiore areazione a vantaggio di un'elevata efficienza.



Attacchi rapidi brevettati, che consentono una pronta e semplice connessione della piastra refrigerante. Pompa del vuoto ad alte prestazioni, per la verifica dell'integrità della piastra prima dell'avvio di ogni servizio.



Impianto frigorifero di ultima generazione con GAS naturale e piastra refrigerante eco-compatibile adatta anche in caso di cremazione ed inumazione.



Silenzioso, compatto, dotato di un maniglione a scomparsa e di due ruote in gomma per un facile trasporto. Struttura in acciaio inox: solida, robusta e resistente.



L'UNICA E LA SOLA PIASTRA REFRIGERANTE BIODEGRADABILE, TUTELATA DA BREVETTO.

I materiali biodegradabili consentono l'utilizzo della piastra anche in casi di cremazione ed inumazione.

THE UNIQUE BIODEGRADABLE REFRIGERANT PLATE, PATENT PROTECTED.

The biodegradable materials allow the use of the plate even in cases of cremation and inhumation.

FR6717

23x43x94 cm

	<p>PIASTRA REFRIGERANTE REFRIGERATION PLATE</p>

FR6716

23x42x88 cm

<i>MATERIALE: ACCIAIO / MATERIAL: STEEL</i>	
<i>FINITURE DISPONIBILI / AVAILABLE FINISHING:</i>	<i>DESCRIZIONE: DESCRIPTION:</i>
	PIASTRA REFRIGERANTE REFRIGERATION PLATE

FR6737

560x410 mm - h440 mm

<i>MATERIALE: ACCIAIO / MATERIAL: STEEL</i>	
<i>FINITURE DISPONIBILI / AVAILABLE FINISHING:</i>	<i>DESCRIZIONE: DESCRIPTION:</i>
	BAULE PER CRIO CRIO TROLLEY

VALVOLE

VALVES

Valvole depuratrici per cofani ermetici dotate di apertura e chiusura meccanica comandate dalla pressione all'interno del cofano. L'apertura della valvola avviene all'incremento di pressione all'interno del cofano di 0.02 bar rispetto alla pressione atmosferica. La chiusura della valvola avviene alla riduzione di pressione all'interno del cofano di 0.008 bar rispetto alla pressione atmosferica. Sicure, pratiche e facili da utilizzare, le valvole Zorsol depurano gli odori grazie ad una miscela di carboni attivi che ne garantisce l'efficienza per tutto il periodo di esercizio. Tutte le valvole Zorsol sono in regola con le Normative Europee, secondo le prescrizioni Eurovent (NF44011 e Nf44013), autorizzate dal Ministero della Sanità con Decreto del 29 Luglio 1999.

Purification valves for airtight casket equipped with mechanical opening and closing systems operated by the internal casket pressure. The valve opening occurs once the pressure inside the casket increases of 0.02 bar compared to outside pressure. The valve closing occurs once the pressure inside the casket decreases of 0.008 bar compared to outside pressure. Safe, practical and easy to use, the Zorsol valves purify the smells thanks to a mixture of active carbons which guarantees the valves efficiency throughout the operating period. All Zorsol valves are in compliance with the European Law, according to the Eurovent regulations (NF44011 and NF44013), authorized by the Ministry of Health by Ordinance dated July 29th 1999.

ZORSOL



VA803

Ø130 mm - h 100 mm

VALVOLA DEPURATRICE/ PURIFICATION VALVE

UTILIZZABILE ANCHE PER TRASPORTO AEREO
ALSO USED FOR AIR TRANSPORT

FISSAGGIO:
FIXING:



M10

VA807

Ø130 mm - h 100 mm

VALVOLA DEPURATRICE/ PURIFICATION VALVE



VALVOLA COMPATTA
COMPACT VALVE

FISSAGGIO:
FIXING:



M10

MANIGLIE

HANDLES

ZORSOL





MA2055

205x75 mm - interasse/wheelbase: 170 mm - 2600N

MATERIALE: OTTONE / MATERIAL: BRASS	
FINITURE DISPONIBILI /AVAILABLE FINISHING: FMM finitura mista: satinata e lucida satin and glossy finishing	FISSAGGIO: /FIXING:  Ø6



MA2057

160x110 mm - 1600N

MATERIALE: OTTONE / MATERIAL: BRASS	
FINITURE DISPONIBILI /AVAILABLE FINISHING: FMM finitura mista: satinata e lucida satin and glossy finishing	FISSAGGIO: /FIXING: 



MA2080

205x80 mm - interasse/wheelbase: 170 mm - 3000N

MATERIALE: OTTONE / MATERIAL: BRASS	
FINITURE DISPONIBILI /AVAILABLE FINISHING: FMM finitura mista: satinata e lucida satin and glossy finishing	FISSAGGIO: /FIXING:  Ø6 - Ø8



infante / enfant
MA0010

130X80 mm - 750N

MATERIALE: ZAMA / MATERIAL: ZAMAK	
FINITURE DISPONIBILI / AVAILABLE FINISHING:	FISSAGGIO: / FIXING:
ORL oro lucido glossy gold	



MA0011

210x100 mm - 1800N

MATERIALE: ZAMA / MATERIAL: ZAMAK	
FINITURE DISPONIBILI / AVAILABLE FINISHING:	FISSAGGIO: / FIXING:
ORL oro lucido glossy gold OTL ottone lucido glossy brass CUL rame lucido glossy copper	

MA0015

230x55 mm - interasse/wheelbase: 160 mm - 2600N

MATERIALE: ZAMA / MATERIAL: ZAMAK	
FINITURE DISPONIBILI / AVAILABLE FINISHING:	FISSAGGIO: / FIXING:
ORL oro lucido glossy gold OTS ottone satinato satin brass	  Ø6

MA0018

125x140 mm - 1050N

MATERIALE: ZAMA / MATERIAL: ZAMAK	
FINITURE DISPONIBILI / AVAILABLE FINISHING:	FISSAGGIO: / FIXING:
ORL oro lucido glossy gold	

MA0019

255X70 mm - interasse/wheelbase: 180 mm - 2800N

MATERIALE: ZAMA / MATERIAL: ZAMAK	
FINITURE DISPONIBILI / AVAILABLE FINISHING:	
ORL	oro lucido glossy gold
OTS	ottone satinato satin brass
NLL	nikel lucido glossy nikel
FISSAGGIO: / FIXING:	
Ø8	

MA0029

290x50 mm - interasse/wheelbase: 230 mm

MATERIALE: ZAMA / MATERIAL: ZAMAK	
FINITURE DISPONIBILI / AVAILABLE FINISHING:	
ORL	oro lucido glossy gold
OTS	ottone satinato satin brass
NLL	nikel lucido glossy nikel
NLS	nikel satinato satin nikel
FISSAGGIO: / FIXING:	
Ø6 - Ø8	

MA0039

255X105 mm - 4600N

MATERIALE: ZAMA / MATERIAL: ZAMAK	
FINITURE DISPONIBILI / AVAILABLE FINISHING:	
ORL	oro lucido glossy gold
OTS	ottone satinato satin brass
NLL	nikel lucido glossy nikel
CUS	rame satinato satin copper
FISSAGGIO: / FIXING:	

MA0042

185x80 mm - interasse/wheelbase: 140mm - 2300N

MATERIALE: ZAMA / MATERIAL: ZAMAK	
FINITURE DISPONIBILI / AVAILABLE FINISHING:	
OTL	ottone lucido glossy brass
FISSAGGIO: / FIXING:	
Ø6	

MA0045

170x110 mm - 1500N

MATERIALE: ZAMA / MATERIAL: ZAMAK	
FINITURE DISPONIBILI /AVAILABLE FINISHING:	FISSAGGIO: FIXING:
ORL oro lucido glossy gold	
OTS ottone satinato satin brass	
CUS rame satinato satin copper	

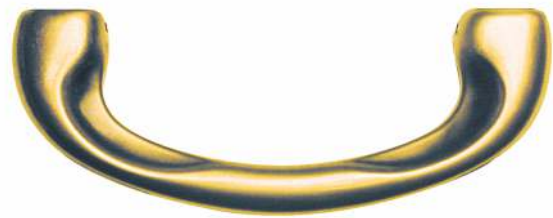
MA0046

210x80 mm - interasse/wheelbase:174 mm - 3200N

MATERIALE: ZAMA / MATERIAL: ZAMAK	
FINITURE DISPONIBILI /AVAILABLE FINISHING:	FISSAGGIO: FIXING:
ORL oro lucido glossy gold	 Ø8
OTS ottone satinato satin brass	
CUS rame satinato satin copper	

MA0048

135X135 mm - 1700N

MATERIALE: ZAMA / MATERIAL: ZAMAK	
FINITURE DISPONIBILI /AVAILABLE FINISHING:	FISSAGGIO: FIXING:
ORL oro lucido glossy gold	
OTS ottone satinato satin brass	
CUS rame satinato satin copper	



MA0049

310x35 mm - 3600N

MATERIALE: ZAMA / MATERIAL: ZAMAK	
FINITURE DISPONIBILI /AVAILABLE FINISHING:	FISSAGGIO: FIXING:
OTS ottone satinato satin brass	



MA0051

245x40 mm - 3500N

MATERIALE: ZAMA / MATERIAL: ZAMAK	
FINITURE DISPONIBILI / AVAILABLE FINISHING: ORL oro lucido glossy gold OTS ottone satinato satin brass CUS rame satinato satin copper	FISSAGGIO: FIXING: 



MA0052

200x80 mm - interasse/wheelbase: 140 mm - 2400N

MATERIALE: ZAMA / MATERIAL: ZAMAK	
FINITURE DISPONIBILI / AVAILABLE FINISHING: OTL ottone lucido glossy brass OTS ottone satinato satin brass	FISSAGGIO: FIXING:  Ø6



MA0080

205x80 mm - interasse/wheelbase: 165 mm - 3000N

MATERIALE: ZAMA / MATERIAL: ZAMAK	
FINITURE DISPONIBILI / AVAILABLE FINISHING: ORL oro lucido glossy gold OTS ottone satinato satin brass NLL nikel lucido glossy nikel CUS rame satinato satin copper	FISSAGGIO: FIXING:  Ø8

MA0081

265x80 mm - interasse/wheelbase: 230 mm - 3000N

MATERIALE: ZAMA / MATERIAL: ZAMAK	
FINITURE DISPONIBILI / AVAILABLE FINISHING: ORL oro lucido glossy gold OTS ottone satinato satin brass	FISSAGGIO: FIXING:  Ø8

MA0082

185x75 mm - interasse/wheelbase: 140 mm - 3000N

MATERIALE: ZAMA / MATERIAL: ZAMAK	
<i>FINITURE DISPONIBILI / AVAILABLE FINISHING:</i>	<i>FISSAGGIO: FIXING:</i>
ORL oro lucido glossy gold	 Ø6
OTS ottone satinato satin brass	
NLS nikel satinato satin nickel	

MA0090

210x80 mm - interasse/wheelbase: 165 mm - 2900N

MATERIALE: ZAMA / MATERIAL: ZAMAK	
<i>FINITURE DISPONIBILI / AVAILABLE FINISHING:</i>	<i>FISSAGGIO: FIXING:</i>
ORL oro lucido glossy gold	
OTS ottone satinato satin brass	
NLL nikel lucido glossy nickel	
CUS rame satinato satin copper	

MA0097

290x40 mm - 2600N

MATERIALE: ZAMA / MATERIAL: ZAMAK	
<i>FINITURE DISPONIBILI / AVAILABLE FINISHING:</i>	<i>FISSAGGIO: FIXING:</i>
ORL oro lucido glossy gold	
OTS ottone satinato satin brass	
NLL nikel lucido glossy nickel	
CUS rame satinato satin copper	



MA0098

235x50 mm - 3000N

MATERIALE: ZAMA / MATERIAL: ZAMAK	
<i>FINITURE DISPONIBILI / AVAILABLE FINISHING:</i>	<i>FISSAGGIO: FIXING:</i>
ORL oro lucido glossy gold	
OTS ottone satinato satin brass	
CUS rame satinato satin copper	



MA0101

290x30 mm - 3400N

MATERIALE: ZAMA / MATERIAL: ZAMAK	
FINITURE DISPONIBILI / AVAILABLE FINISHING: ORL oro lucido glossy gold OTS ottone satinato satin brass CUS rame satinato satin copper	FISSAGGIO: FIXING: 



MA0104

260x50 mm - interasse/wheelbase: 230 mm - 3000N

MATERIALE: ZAMA / MATERIAL: ZAMAK	
FINITURE DISPONIBILI / AVAILABLE FINISHING: ORL oro lucido glossy gold OTS ottone satinato satin brass	FISSAGGIO: FIXING:  Ø8



MA0105

260x55.5 mm - interasse/wheelbase: 230 mm - 3000N

MATERIALE: ZAMA / MATERIAL: ZAMAK	
FINITURE DISPONIBILI / AVAILABLE FINISHING: ORL oro lucido glossy gold OTS ottone satinato satin brass CUS rame satinato satin copper	FISSAGGIO: FIXING:   Ø6



MT0005

da/from 270 a/to 1700 mm - Ø22- 2000N

MATERIALE: ZAMA / MATERIAL: ZAMAK	
FINITURE DISPONIBILI / AVAILABLE FINISHING: ORL oro lucido glossy gold OTS ottone satinato satin brass NLL nikel lucido glossy nikel NLS nikel satinato satin nikel	FISSAGGIO: FIXING:   Ø8



MT0036

290x105 mm - Ø30 - 3000N

MATERIALE: ZAMA / MATERIAL: ZAMAK	
FINITURE DISPONIBILI / AVAILABLE FINISHING: ORL oro lucido glossy gold OTS ottone satinato satin brass	FISSAGGIO: / FIXING: 



MT0050

da/from 350 a/to 1670 mm - Ø30 - 2600N

MATERIALE: ZAMA / MATERIAL: ZAMAK	
FINITURE DISPONIBILI / AVAILABLE FINISHING: ORL oro lucido glossy gold OTS ottone satinato satin brass NLL nikel lucido glossy nikel CUS rame satinato satin copper	FISSAGGIO: / FIXING:   Ø8



MT0051

340X80 mm - Ø30 - interasse/wheelbase:230 mm - 3000N

MATERIALE: ZAMA / MATERIAL: ZAMAK	
FINITURE DISPONIBILI / AVAILABLE FINISHING: ORL oro lucido glossy gold OTS ottone satinato satin brass NLL nikel lucido glossy nikel CUS rame satinato satin copper	FISSAGGIO: / FIXING:  Ø8

MT0073

da/from 350 a/to 1120 mm - Ø22 - 2800N

MATERIALE: ZAMA / MATERIAL: ZAMAK	
FINITURE DISPONIBILI / AVAILABLE FINISHING: ORL oro lucido glossy gold OTS ottone satinato satin brass CUS rame satinato satin copper	FISSAGGIO: / FIXING: 

MT0088

da/from 280 a/to 1800 mm - Ø24 - 2000N

MATERIALE: ZAMA / MATERIAL: ZAMAK	
FINITURE DISPONIBILI /AVAILABLE FINISHING:	FISSAGGIO: /FIXING:
ORL oro lucido /glossy gold	 Ø6
OTS ottone satinato /satin brass	

MT0096

300x95 mm - Ø24 - 2800N

MATERIALE: ZAMA / MATERIAL: ZAMAK	
FINITURE DISPONIBILI /AVAILABLE FINISHING:	FISSAGGIO: /FIXING:
ORL oro lucido /glossy gold	
OTS ottone satinato /satin brass	
CUS rame satinato /satin copper	

MU0102

260X55.5 mm - interasse/wheelbase: 230 mm - 3000N

MATERIALE: ZAMA / MATERIAL: ZAMAK	
FINITURE DISPONIBILI /AVAILABLE FINISHING:	FISSAGGIO: /FIXING:
OTS / NLS ottone satinato /nikel satinato /satin brass /satin nikel	 Ø8
ORL / NLS oro lucido /nikel satinato /glossy gold /satin nikel	
NLL / NLS nikel lucido /nikel satinato /glossy nikel /satin nikel	
ORL / NLL oro lucido /nikel lucido /glossy gold /glossy nikel	

MA3000

295x19mm - 1800N

MATERIALE: ALLUMINIO / MATERIAL: ALUMINIUM	
FINITURE DISPONIBILI / AVAILABLE FINISHING:	FISSAGGIO: / FIXING:
ORL oro lucido glossy gold	
OTS ottone satinato satin brass	

MA3029

290X50 mm - interasse 230 mm - 3000N

MATERIALE: ALLUMINIO / MATERIAL: ALUMINIUM	
FINITURE DISPONIBILI / AVAILABLE FINISHING:	FISSAGGIO: / FIXING:
ORL oro lucido glossy gold	 Ø8
OTS ottone satinato satin brass	

MA3009

235X130 mm - 3000N

MATERIALE: ALLUMINIO / MATERIAL: ALUMINIUM	
FINITURE DISPONIBILI / AVAILABLE FINISHING:	FISSAGGIO: / FIXING:
ORL oro lucido glossy gold	
CUS rame satinato satin copper	



MA3080

205x80 mm - interasse/wheelbase: 165 mm - 3000N

MATERIALE: ALLUMINIO / MATERIAL: ALUMINIUM	
FINITURE DISPONIBILI / AVAILABLE FINISHING:	FISSAGGIO: / FIXING:
ORL oro lucido glossy gold	
OTS ottone satinato satin brass	
NLL nikel lucido glossy nikel	

MA5001

310x25 - h50 mm - 3000N

<i>MATERIALE: LEGNO / MATERIAL: WOOD</i>	
<i>FINITURE DISPONIBILI / AVAILABLE FINISHING:</i> <i>legno naturale / natural wood</i>	<i>FISSAGGIO: / FIXING:</i> 

MA5002

310x25 - h50 mm - 3000N

<i>MATERIALE: LEGNO / MATERIAL: WOOD</i>	
<i>FINITURE DISPONIBILI / AVAILABLE FINISHING:</i> <i>legno verniciato / painted wood</i>	<i>FISSAGGIO: / FIXING:</i> 

PLASTICA

MA4007

220x60 mm - interasse/wheelbase: 170 mm - 1600N

<i>MATERIALE: PLASTICA / MATERIAL: PLASTIC</i>	
<i>FINITURE DISPONIBILI / AVAILABLE FINISHING:</i> ORL <i>oro lucido / glossy gold</i>	<i>FISSAGGIO: / FIXING:</i>  Ø6

CROCI

CROSSES

ZORSOL



CR201

200x600mm

CR202

150x600 mm

MATERIALE: OTTONE / MATERIAL: BRASS

FINITURE DISPONIBILI / AVAILABLE FINISHING:

- FML** *finitura lucida*
glossy finishing
- FMS** *finitura satinata*
satin finishing
- NLS** *nikel satinato*
satin nickel

 FISSAGGIO:
 FIXING:

MATERIALE: OTTONE / MATERIAL: BRASS

FINITURE DISPONIBILI / AVAILABLE FINISHING:

- FML** *finitura lucida*
glossy finishing

 FISSAGGIO:
 FIXING:

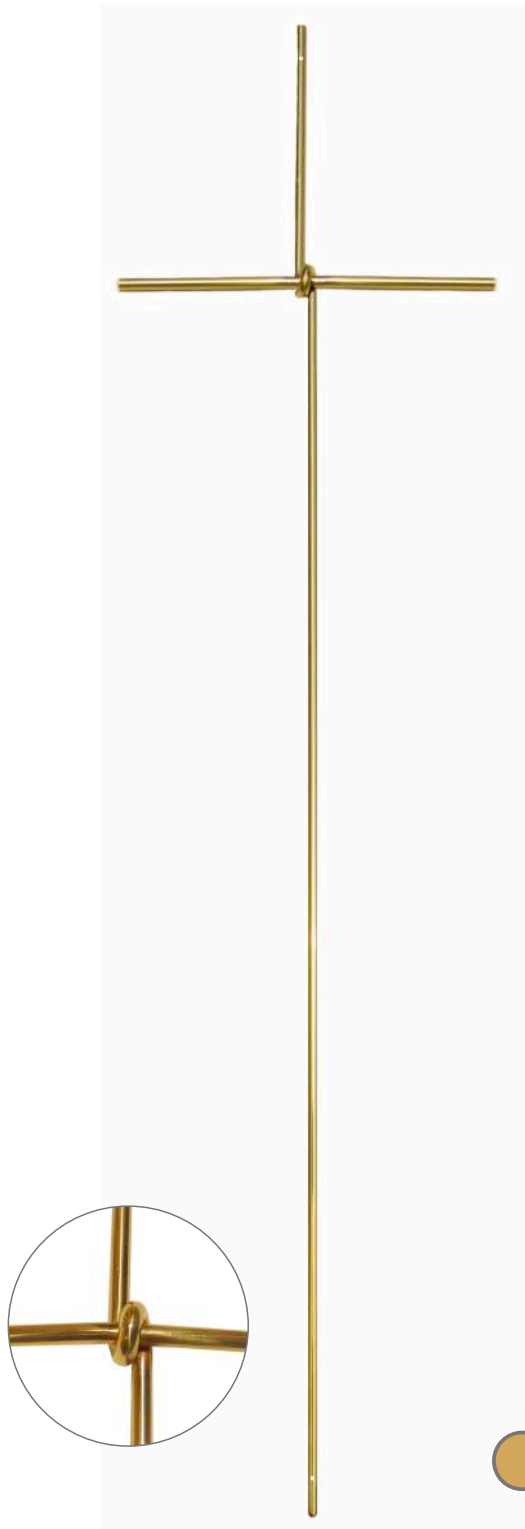
CR203

147x650mm



CR204

170x555 mm

MATERIALE: OTTONE / MATERIAL: BRASS	
FINITURE DISPONIBILI / AVAILABLE FINISHING: FML finitura lucida glossy finishing	FISSAGGIO: FIXING: 

MATERIALE: OTTONE / MATERIAL: BRASS	
FINITURE DISPONIBILI / AVAILABLE FINISHING: FML finitura lucida glossy finishing	FISSAGGIO: FIXING: 

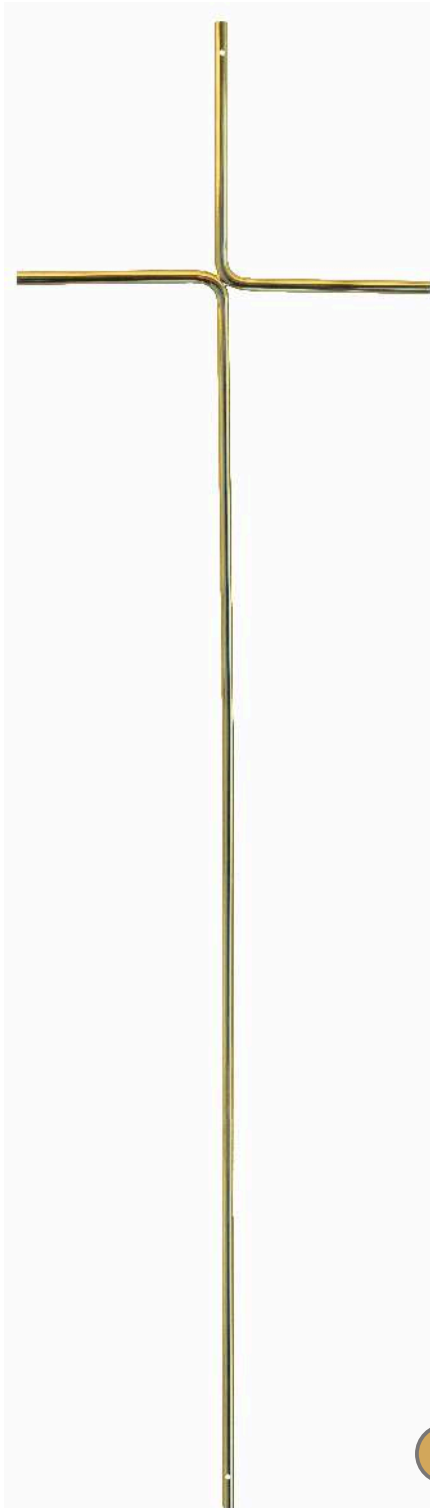

CR208

158x565mm



CR209

180x560mm

MATERIALE: OTTONE / MATERIAL: BRASS	
FINITURE DISPONIBILI / AVAILABLE FINISHING: FML finitura lucida glossy finishing	FISSAGGIO: FIXING:

MATERIALE: OTTONE / MATERIAL: BRASS	
FINITURE DISPONIBILI / AVAILABLE FINISHING: FML finitura lucida glossy finishing personalizzabile con strass customizable with strass	FISSAGGIO: FIXING:

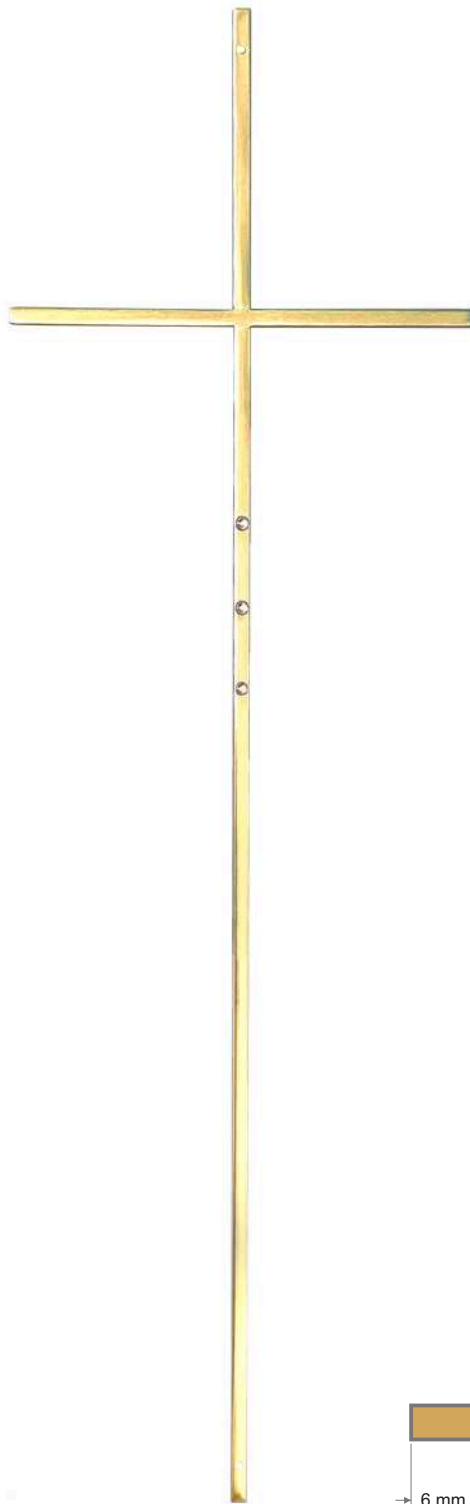

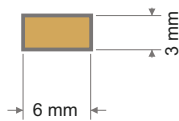

CR210
170x560mm

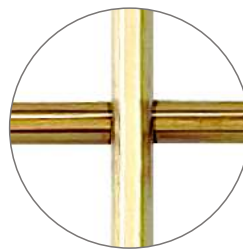

CR211
160x560mm



MATERIALE: OTTONE / MATERIAL: BRASS	
FINITURE DISPONIBILI / AVAILABLE FINISHING: FML finitura lucida glossy finishing personalizzabile con strass customizable with strass	FISSAGGIO: FIXING: 

MATERIALE: OTTONE / MATERIAL: BRASS	
FINITURE DISPONIBILI / AVAILABLE FINISHING: FML finitura lucida glossy finishing personalizzabile con strass customizable with strass	FISSAGGIO: FIXING: 



CR212
155x560mm



CR213
155x560mm

<i>MATERIALE: OTTONE / MATERIAL: BRASS</i>	
<i>FINITURE DISPONIBILI / AVAILABLE FINISHING:</i>	<i>FISSAGGIO: / FIXING:</i>
FML <i>finitura lucida / glossy finishing</i>	
<i>personalizzabile con strass / customizable with strass</i>	

<i>MATERIALE: OTTONE / MATERIAL: BRASS</i>	
<i>FINITURE DISPONIBILI / AVAILABLE FINISHING:</i>	<i>FISSAGGIO: / FIXING:</i>
FML <i>finitura lucida / glossy finishing</i>	
<i>personalizzabile con strass / customizable with strass</i>	



CR221

160x640mm



CR225

200x800 mm



MATERIALE: OTTONE / MATERIAL: BRASS	
FINITURE DISPONIBILI / AVAILABLE FINISHING:	
FML	<i>finitura lucida glossy finishing</i>
FMS	<i>finitura satinata satin finishing</i>
CUS	<i>rame satinato satin copper</i>
NLL	<i>nikel lucido glossy nikel</i>
FISSAGGIO: / FIXING:	

MATERIALE: OTTONE / MATERIAL: BRASS	
FINITURE DISPONIBILI / AVAILABLE FINISHING:	
FML	<i>finitura lucida glossy finishing</i>
FISSAGGIO: / FIXING:	

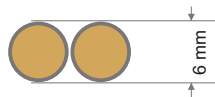

CR226

200x800mm

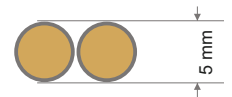

CR227

150x650mm

MATERIALE: OTTONE / MATERIAL: BRASS	
FINITURE DISPONIBILI / AVAILABLE FINISHING: FMS finitura satinata satin finishing	FISSAGGIO: FIXING:

MATERIALE: OTTONE / MATERIAL: BRASS	
FINITURE DISPONIBILI / AVAILABLE FINISHING: FML finitura lucida glossy finishing FMS finitura satinata satin finishing	FISSAGGIO: FIXING:



CR261

175x560mm



CR271

200x450mm

MATERIALE: OTTONE / MATERIAL: BRASS	
FINITURE DISPONIBILI / AVAILABLE FINISHING: FML finitura lucida glossy finishing	FISSAGGIO: FIXING: 

MATERIALE: OTTONE / MATERIAL: BRASS	
FINITURE DISPONIBILI / AVAILABLE FINISHING: FML finitura lucida glossy finishing	FISSAGGIO: FIXING: 

CR150

185x595 mm

CR151

200x615 mm

MATERIALE: METALLO / MATERIAL: METAL	
FINITURE DISPONIBILI / AVAILABLE FINISHING:	FISSAGGIO: / FIXING:
OTS ottone satinato / satin brass	
ORL oro lucido / glossy gold	

MATERIALE: METALLO / MATERIAL: METAL	
FINITURE DISPONIBILI / AVAILABLE FINISHING:	FISSAGGIO: / FIXING:
OTS ottone satinato / satin brass	
ORL oro lucido / glossy gold	
CUS rame satinato / satin copper	
NLL nikel lucido / glossy nickel	

CR152

170x670 mm

CR156

185x580 mm

MATERIALE: METALLO / MATERIAL: METAL	
FINITURE DISPONIBILI / AVAILABLE FINISHING:	
OTS	ottone satinato satin brass
ORL	oro lucido glossy gold
CUS	rame satinato satin copper
NLL	nikel lucido glossy nikel
FISSAGGIO: / FIXING:	

MATERIALE: METALLO / MATERIAL: METAL	
FINITURE DISPONIBILI / AVAILABLE FINISHING:	
ORL	oro lucido glossy gold
FISSAGGIO: / FIXING:	

CR002

190x470 mm

CR003

175x560mm

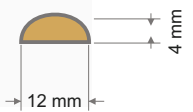

MATERIALE: ZAMA / MATERIAL: ZAMAK

FINITURE DISPONIBILI / AVAILABLE FINISHING:

OTS	ottone satinato satin brass
ORL	oro lucido glossy gold
CUS	rame satinato satin copper
NLL	nikel lucido glossy nickel

 FISSAGGIO:
 FIXING:

MATERIALE: ZAMA / MATERIAL: ZAMAK

FINITURE DISPONIBILI / AVAILABLE FINISHING:

OTS	ottone satinato satin brass
ORL	oro lucido glossy gold
CUS	rame satinato satin copper
NLL	nikel lucido glossy nickel

 FISSAGGIO:
 FIXING:



CR034

180x450 mm

CR040

180x570mm

MATERIALE: ZAMA / MATERIAL: ZAMAK					
FINITURE DISPONIBILI / AVAILABLE FINISHING: <table border="0"> <tr> <td style="background-color: #c0c0c0; padding: 2px;">OTS</td> <td style="padding: 2px;"><i>ottone satinato</i> satin brass</td> </tr> <tr> <td style="background-color: #ffff00; padding: 2px;">ORL</td> <td style="padding: 2px;"><i>oro lucido</i> glossy gold</td> </tr> </table>	OTS	<i>ottone satinato</i> satin brass	ORL	<i>oro lucido</i> glossy gold	FISSAGGIO: / FIXING: 
OTS	<i>ottone satinato</i> satin brass				
ORL	<i>oro lucido</i> glossy gold				

MATERIALE: ZAMA / MATERIAL: ZAMAK											
FINITURE DISPONIBILI / AVAILABLE FINISHING: <table border="0"> <tr> <td style="background-color: #c0c0c0; padding: 2px;">OTS</td> <td style="padding: 2px;"><i>ottone satinato</i> satin brass</td> </tr> <tr> <td style="background-color: #ffff00; padding: 2px;">ORL</td> <td style="padding: 2px;"><i>oro lucido</i> glossy gold</td> </tr> <tr> <td style="background-color: #a0522d; padding: 2px;">CUS</td> <td style="padding: 2px;"><i>rame satinato</i> satin copper</td> </tr> <tr> <td style="background-color: #696969; padding: 2px;">PES</td> <td style="padding: 2px;"><i>peltro</i> pewter</td> </tr> <tr> <td style="background-color: #d3d3d3; padding: 2px;">NLL</td> <td style="padding: 2px;"><i>nikel lucido</i> glossy nikel</td> </tr> </table>	OTS	<i>ottone satinato</i> satin brass	ORL	<i>oro lucido</i> glossy gold	CUS	<i>rame satinato</i> satin copper	PES	<i>peltro</i> pewter	NLL	<i>nikel lucido</i> glossy nikel	FISSAGGIO: / FIXING: 
OTS	<i>ottone satinato</i> satin brass										
ORL	<i>oro lucido</i> glossy gold										
CUS	<i>rame satinato</i> satin copper										
PES	<i>peltro</i> pewter										
NLL	<i>nikel lucido</i> glossy nikel										

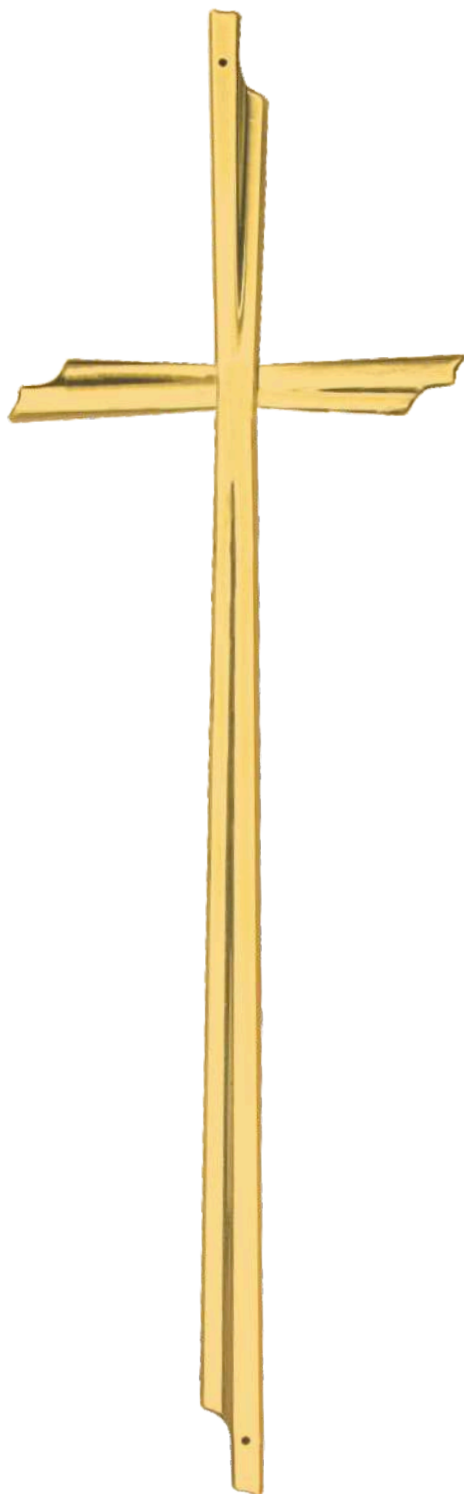

CR041

165x525 mm

<i>MATERIALE: ZAMA / MATERIAL: ZAMAK</i>	
<p><i>FINITURE DISPONIBILI / AVAILABLE FINISHING:</i></p> <p>OTS <i>ottone satinato</i> <i>satin brass</i></p> <p>ORL <i>oro lucido</i> <i>glossy gold</i></p> <p>CUS <i>rame satinato</i> <i>satin copper</i></p> <p>PES <i>peltro</i> <i>pewter</i></p> <p>NLL <i>nikel lucido</i> <i>glossy nikel</i></p>	<p><i>FISSAGGIO:</i> <i>FIXING:</i></p> 

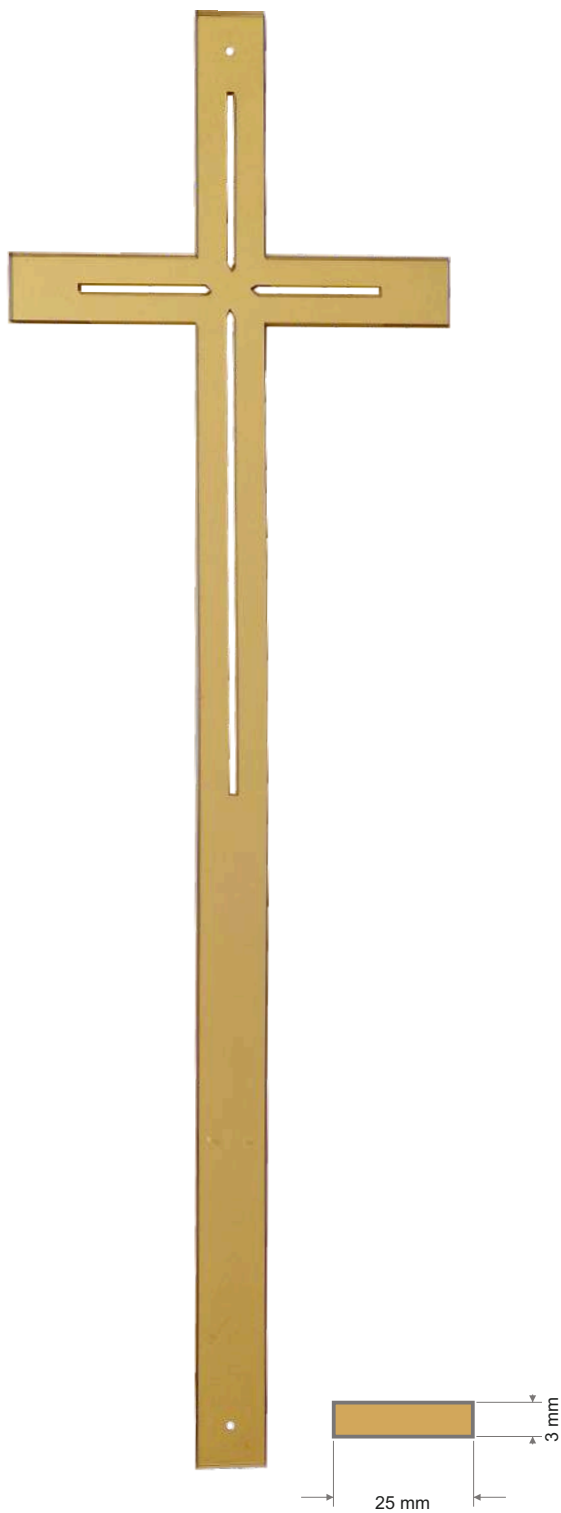

CR470

160x530 mm

MATERIALE: PLEXIGLASS / MATERIAL: PLEXIGLASS	
FINITURE DISPONIBILI / AVAILABLE FINISHING:	
OTS	<i>ottone satinato</i> <i>satin brass</i>
ORL	<i>oro lucido</i> <i>glossy gold</i>
NLL	<i>nikel lucido</i> <i>glossy nikel</i>
FISSAGGIO: FIXING:	



CR503

235x640 mm



CR504

235x640 mm

<i>MATERIALE: LEGNO / MATERIAL: WOOD</i>	
<i>FINITURE DISPONIBILI / AVAILABLE FINISHING:</i> <i>legno naturale / natural wood</i>	<i>FISSAGGIO:</i> <i>FIXING:</i> 

<i>MATERIALE: LEGNO / MATERIAL: WOOD</i>	
<i>FINITURE DISPONIBILI / AVAILABLE FINISHING:</i> <i>legno verniciato / painted wood</i>	<i>FISSAGGIO:</i> <i>FIXING:</i> 



CR501

1410x630mm

<i>MATERIALE: LEGNO / MATERIAL: WOOD</i>	
<i>FINITURE DISPONIBILI / AVAILABLE FINISHING:</i> <i>legno verniciato / painted wood</i>	<i>CIMITERIALE</i> <i>CEMETERY</i>



CR502

1440x700mm

<i>MATERIALE: LEGNO / MATERIAL: WOOD</i>	
<i>FINITURE DISPONIBILI / AVAILABLE FINISHING:</i> <i>legno verniciato / painted wood</i>	<i>CIMITERIALE</i> <i>CEMETERY</i>

CROCIFISSI

CRUCIFIXES

ZORSOL





CR221+CS002L

160X640 mm



CR221+CS004

160X640 mm

MATERIALE: OTTONE E ZAMA / MATERIAL: BRASS & ZAMAK

FINITURE DISPONIBILI / AVAILABLE FINISHING:

NLL	<i>nikel lucido glossy nickel</i>	NLL	<i>nikel lucido glossy nickel</i>
FML	<i>finitura lucida glossy finishing</i>	ORL	<i>oro lucido glossy gold</i>
FMS	<i>finitura satinata satin finishing</i>	OTS	<i>ottone satinato satin brass</i>
CUS	<i>rame satinato satin copper</i>	CUS	<i>rame satinato satin copper</i>

MATERIALE: OTTONE E ZAMA / MATERIAL: BRASS & ZAMAK

FINITURE DISPONIBILI / AVAILABLE FINISHING:

FML	<i>finitura lucida glossy finishing</i>	ORL	<i>oro lucido glossy gold</i>
FMS	<i>finitura satinata satin finishing</i>	OTS	<i>ottone satinato satin brass</i>
CUS	<i>rame satinato satin copper</i>	CUS	<i>rame satinato satin copper</i>



CR221+CS006

160X640 mm

MATERIALE: OTTONE E ZAMA / MATERIAL: BRASS & ZAMAK

FINITURE DISPONIBILI / AVAILABLE FINISHING:

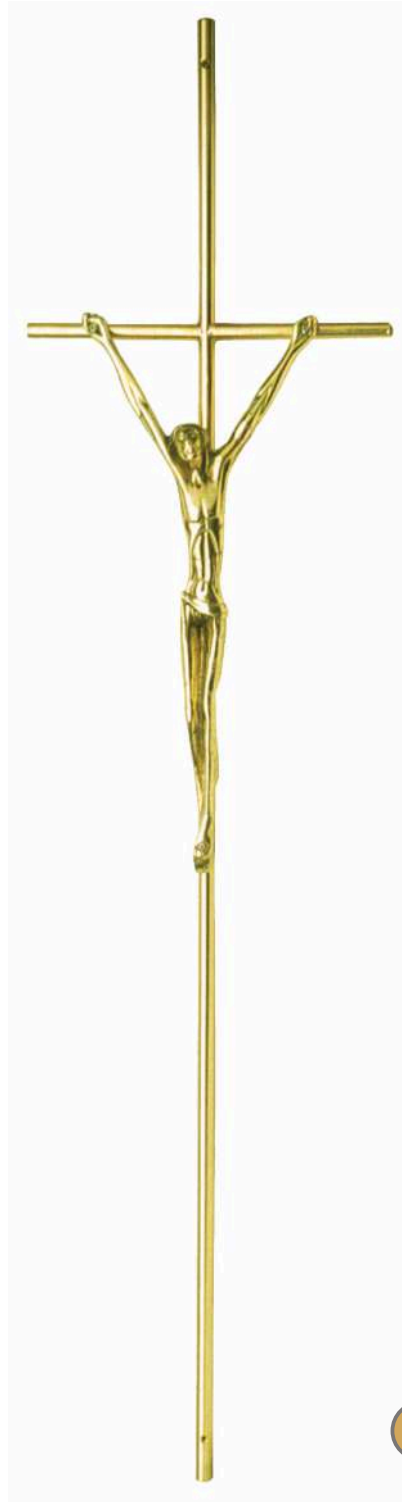
NLL	<i>nikel lucido glossy nikel</i>	NLL	<i>nikel lucido glossy nikel</i>
FML	<i>finitura lucida glossy finishing</i>	ORL	<i>oro lucido glossy gold</i>
FMS	<i>finitura satinata satin finishing</i>	OTS	<i>ottone satinato satin brass</i>
CUS	<i>rame satinato satin copper</i>	CUS	<i>rame satinato satin copper</i>

CR221+CS010

160X640 mm

MATERIALE: OTTONE E ZAMA / MATERIAL: BRASS & ZAMAK

FINITURE DISPONIBILI / AVAILABLE FINISHING:

NLL	<i>nikel lucido glossy nikel</i>	NLL	<i>nikel lucido glossy nikel</i>
FML	<i>finitura lucida glossy finishing</i>	ORL	<i>oro lucido glossy gold</i>
FMS	<i>finitura satinata satin finishing</i>	OTS	<i>ottone satinato satin brass</i>
CUS	<i>rame satinato satin copper</i>	CUS	<i>rame satinato satin copper</i>



CR221+CS011

160X640 mm

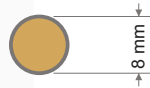

CR228+CS002L

160X640 mm

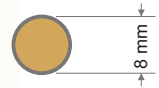

MATERIALE: OTTONE E ZAMA / MATERIAL: BRASS & ZAMAK

FINITURE DISPONIBILI / AVAILABLE FINISHING:

NLL	<i>nikel lucido glossy nikel</i>	NLL	<i>nikel lucido glossy nikel</i>
FML	<i>finitura lucida glossy finishing</i>	FML	<i>finitura lucida glossy finishing</i>
FMS	<i>finitura satinata satin finishing</i>	FMS	<i>finitura satinata satin finishing</i>
CUS	<i>rame satinato satin copper</i>	CUS	<i>rame satinato satin copper</i>

MATERIALE: OTTONE E ZAMA / MATERIAL: BRASS & ZAMAK

FINITURE DISPONIBILI / AVAILABLE FINISHING:

FML	<i>finitura lucida glossy finishing</i>	ORL	<i>oro lucido glossy gold</i>
FMS	<i>finitura satinata satin finishing</i>	OTS	<i>ottone satinato satin brass</i>

Croce componibile con svariate
 rose di differente colore

FC1778

FC1783

FC1777

FC1780

FC1779

FC1784

FC1781

FC1785

CR221+FC1782

160x640 mm

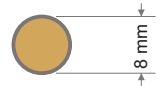

CR221	FC17##																								
MATERIALE: OTTONE / MATERIAL: BRASS	MATERIALE: METALLO / MATERIAL: METAL																								
FINITURE DISPONIBILI / AVAILABLE FINISHING:	FINITURE DISPONIBILI / AVAILABLE FINISHING:																								
ORL oro lucido glossy gold	<table style="width: 100%; border: none;"> <tr> <td style="border: 1px solid black; padding: 2px;">FC1780AGL</td> <td style="padding: 2px;"><i>rosa blu</i> blue rose</td> <td style="border: 1px solid black; padding: 2px;">FC1777AGL</td> <td style="padding: 2px;"><i>rosa rosa</i> pink rose</td> </tr> <tr> <td style="border: 1px solid black; padding: 2px;">FC1781AGL</td> <td style="padding: 2px;"><i>rosa gialla</i> yellow rose</td> <td style="border: 1px solid black; padding: 2px;">FC1778ORL</td> <td style="padding: 2px;"><i>rosa rosa</i> pink rose</td> </tr> <tr> <td style="border: 1px solid black; padding: 2px;">FC1782ORL</td> <td style="padding: 2px;"><i>rosa rossa</i> red rose</td> <td></td> <td></td> </tr> <tr> <td style="border: 1px solid black; padding: 2px;">FC1783ORL</td> <td style="padding: 2px;"><i>rosa bianca</i> white rose</td> <td></td> <td></td> </tr> <tr> <td style="border: 1px solid black; padding: 2px;">FC1784AGL</td> <td style="padding: 2px;"><i>rosa bianca</i> white rose</td> <td></td> <td></td> </tr> <tr> <td style="border: 1px solid black; padding: 2px;">FC1785AGL</td> <td style="padding: 2px;"><i>rosa rossa</i> red rose</td> <td></td> <td></td> </tr> </table>	FC1780AGL	<i>rosa blu</i> blue rose	FC1777AGL	<i>rosa rosa</i> pink rose	FC1781AGL	<i>rosa gialla</i> yellow rose	FC1778ORL	<i>rosa rosa</i> pink rose	FC1782ORL	<i>rosa rossa</i> red rose			FC1783ORL	<i>rosa bianca</i> white rose			FC1784AGL	<i>rosa bianca</i> white rose			FC1785AGL	<i>rosa rossa</i> red rose		
FC1780AGL	<i>rosa blu</i> blue rose	FC1777AGL	<i>rosa rosa</i> pink rose																						
FC1781AGL	<i>rosa gialla</i> yellow rose	FC1778ORL	<i>rosa rosa</i> pink rose																						
FC1782ORL	<i>rosa rossa</i> red rose																								
FC1783ORL	<i>rosa bianca</i> white rose																								
FC1784AGL	<i>rosa bianca</i> white rose																								
FC1785AGL	<i>rosa rossa</i> red rose																								



CR225+CS002L

200X800 mm

MATERIALE: OTTONE E ZAMA / MATERIAL: BRASS & ZAMAK

FINITURE DISPONIBILI / AVAILABLE FINISHING:

FML finitura lucida
glossy finishing

ORL oro lucido
glossy gold

OTS ottone satinato
satin brass



CR225+FC1760

200X800 mm

MATERIALE: OTTONE E METALLO / MATERIAL: BRASS & METAL

FINITURE DISPONIBILI / AVAILABLE FINISHING:

FML finitura lucida
glossy finishing

ORL oro lucido
glossy gold

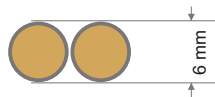

CR226+FC2602

200x800 mm

MATERIALE: OTTONE / MATERIAL: BRASS

FINITURE DISPONIBILI / AVAILABLE FINISHING:

FMS finitura satinata
satin finishing

FMS finitura satinata
satin finishing

FML finitura lucida
glossy finishing

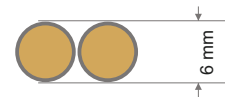

CR227+CS010

150x650mm

MATERIALE: OTTONE E ZAMA / MATERIAL: BRASS & ZAMAK

FINITURE DISPONIBILI / AVAILABLE FINISHING:

FML finitura lucida
glossy finishing

ORL oro lucido
glossy gold

FMS finitura satinata
satin finishing

OTS ottone satinato
satin brass

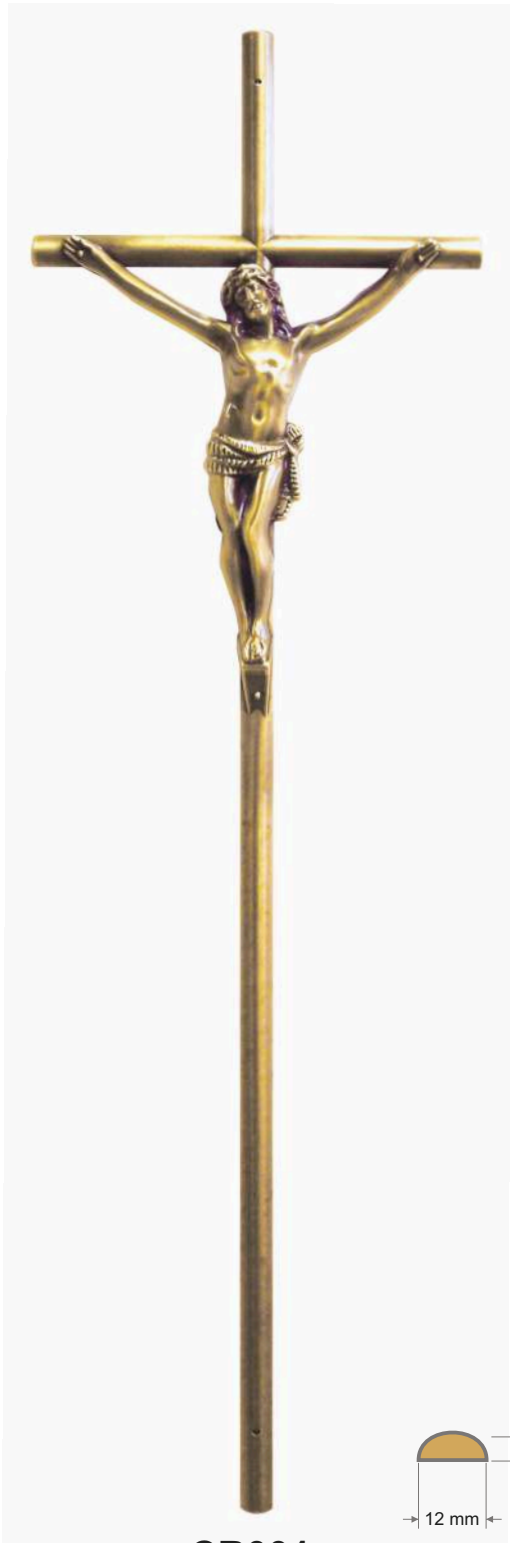

CR001

160x530 mm

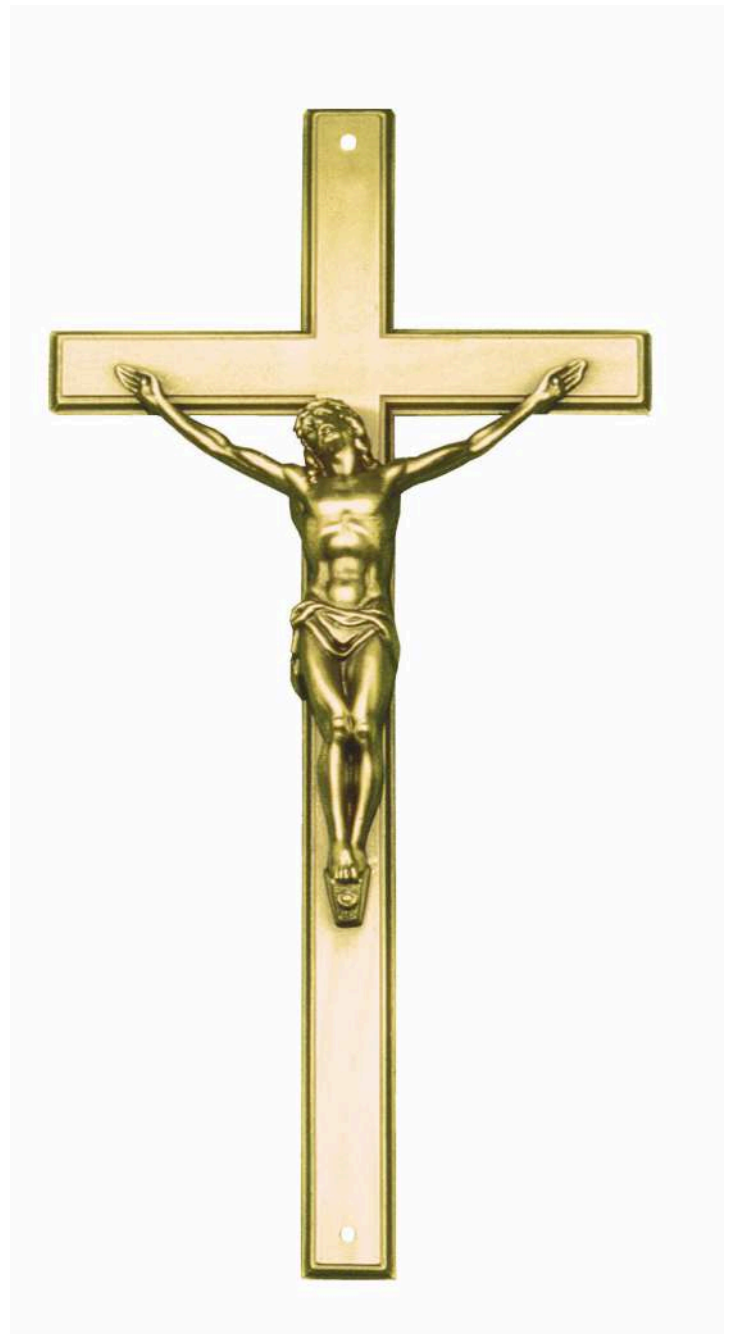

CR022

210x460 mm

MATERIALE: ZAMA / MATERIAL: ZAMAK	
FINITURE DISPONIBILI / AVAILABLE FINISHING:	
OTS	ottone satinato satin brass
ORL	oro lucido glossy gold
CUS	rame satinato satin copper
NLL	nikel lucido glossy nikel

MATERIALE: ZAMA / MATERIAL: ZAMAK	
FINITURE DISPONIBILI / AVAILABLE FINISHING:	
ORL	oro lucido glossy gold
OTS	ottone satinato satin brass
CUS	rame satinato satin copper



CR003+CS005

160X565 mm



CR003+CS006

175X560 mm

MATERIALE: ZAMA / MATERIAL: ZAMAK

FINITURE DISPONIBILI / AVAILABLE FINISHING:

ORL	<i>oro lucido glossy gold</i>	ORL	<i>oro lucido glossy gold</i>
OTS	<i>ottone satinato satin brass</i>	OTS	<i>ottone satinato satin brass</i>

MATERIALE: ZAMA / MATERIAL: ZAMAK

FINITURE DISPONIBILI / AVAILABLE FINISHING:

NLL	<i>nikel lucido glossy nikel</i>	NLL	<i>nikel lucido glossy nikel</i>
ORL	<i>oro lucido glossy gold</i>	ORL	<i>oro lucido glossy gold</i>
OTS	<i>ottone satinato satin brass</i>	OTS	<i>ottone satinato satin brass</i>
CUS	<i>rame satinato satin copper</i>	CUS	<i>rame satinato satin copper</i>

Croce componibile con svariate
rose di differente colore



FC1778



FC1783



FC1777



FC1780



FC1779



FC1784



FC1781



FC1785



CR003+FC1782

175x560 mm

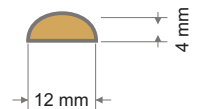

CR003	FC17##																								
MATERIALE: ZAMA / MATERIAL: ZAMAK	MATERIALE: METALLO / MATERIAL: METAL																								
FINITURE DISPONIBILI / AVAILABLE FINISHING:	FINITURE DISPONIBILI / AVAILABLE FINISHING:																								
ORL oro lucido glossy gold	<table style="width: 100%; border: none;"> <tr> <td style="border: 1px solid black; padding: 2px;">FC1780AGL</td> <td style="padding: 2px;">rosa blu blue rose</td> <td style="border: 1px solid black; padding: 2px;">FC1777AGL</td> <td style="padding: 2px;">rosa rosa pink rose</td> </tr> <tr> <td style="border: 1px solid black; padding: 2px;">FC1781AGL</td> <td style="padding: 2px;">rosa gialla yellow rose</td> <td style="border: 1px solid black; padding: 2px;">FC1778ORL</td> <td style="padding: 2px;">rosa rosa pink rose</td> </tr> <tr> <td style="border: 1px solid black; padding: 2px;">FC1782ORL</td> <td style="padding: 2px;">rosa rossa red rose</td> <td></td> <td></td> </tr> <tr> <td style="border: 1px solid black; padding: 2px;">FC1783ORL</td> <td style="padding: 2px;">rosa bianca white rose</td> <td></td> <td></td> </tr> <tr> <td style="border: 1px solid black; padding: 2px;">FC1784AGL</td> <td style="padding: 2px;">rosa bianca white rose</td> <td></td> <td></td> </tr> <tr> <td style="border: 1px solid black; padding: 2px;">FC1785AGL</td> <td style="padding: 2px;">rosa rossa red rose</td> <td></td> <td></td> </tr> </table>	FC1780AGL	rosa blu blue rose	FC1777AGL	rosa rosa pink rose	FC1781AGL	rosa gialla yellow rose	FC1778ORL	rosa rosa pink rose	FC1782ORL	rosa rossa red rose			FC1783ORL	rosa bianca white rose			FC1784AGL	rosa bianca white rose			FC1785AGL	rosa rossa red rose		
FC1780AGL	rosa blu blue rose	FC1777AGL	rosa rosa pink rose																						
FC1781AGL	rosa gialla yellow rose	FC1778ORL	rosa rosa pink rose																						
FC1782ORL	rosa rossa red rose																								
FC1783ORL	rosa bianca white rose																								
FC1784AGL	rosa bianca white rose																								
FC1785AGL	rosa rossa red rose																								



CR004

175 x 465 mm



CR005

200x390 mm

MATERIALE: ZAMA / MATERIAL: ZAMAK

FINITURE DISPONIBILI / AVAILABLE FINISHING:

- ORL** oro lucido
glossy gold
- OTS** ottone satinato
satin brass

MATERIALE: ZAMA / MATERIAL: ZAMAK

FINITURE DISPONIBILI / AVAILABLE FINISHING:

- NLL** nikel lucido
glossy nickel
- ORL** oro lucido
glossy gold
- OTS** ottone satinato
satin brass
- CUS** rame satinato
satin copper

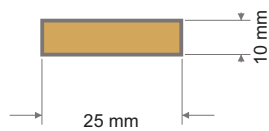

CR026+CS002

200x470 mm

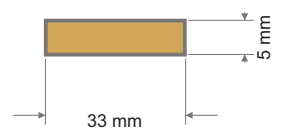

CR027

180x480 mm

MATERIALE: ZAMA / MATERIAL: ZAMAK

FINITURE DISPONIBILI / AVAILABLE FINISHING:

- OTS** ottone satinato
satin brass
- ORL** oro lucido
glossy gold

MATERIALE: ZAMA / MATERIAL: ZAMAK

FINITURE DISPONIBILI / AVAILABLE FINISHING:

- OTS** ottone satinato
satin brass
- ORL** oro lucido
glossy gold
- CUS** rame satinato
satin copper



CR033

180x450 mm

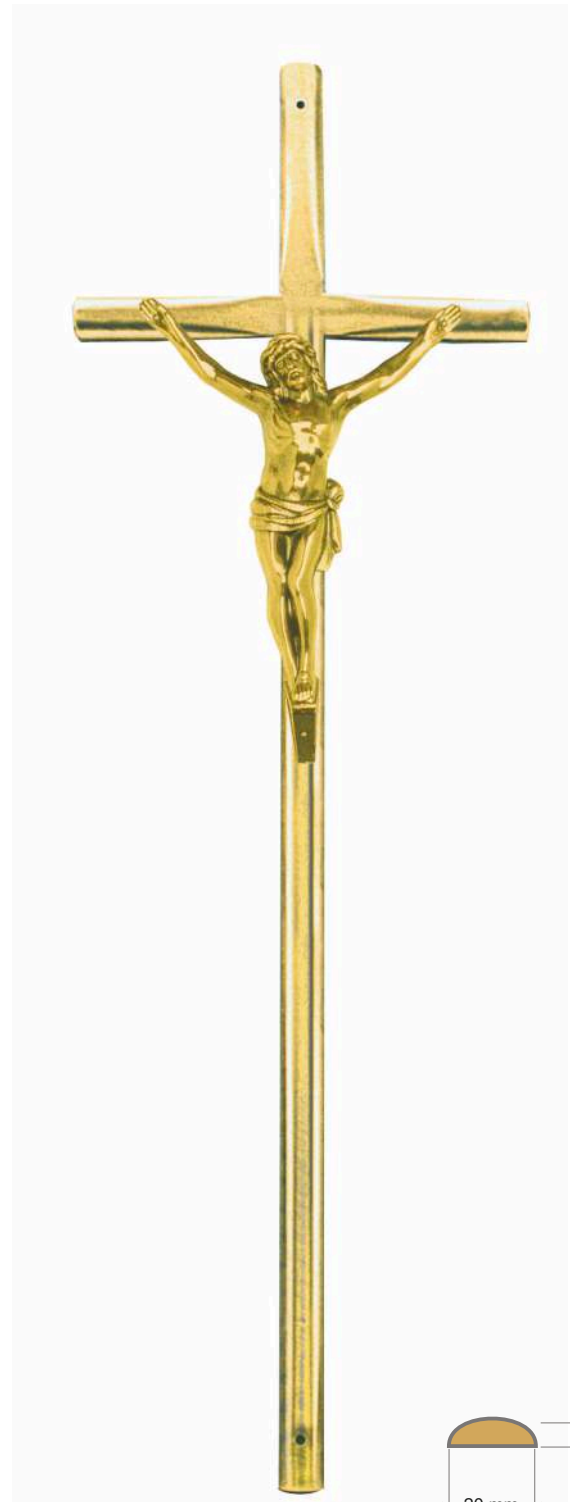

CR040+CS002L

180x570 mm

MATERIALE: ZAMA / MATERIAL: ZAMAK

FINITURE DISPONIBILI / AVAILABLE FINISHING:

OTS	ottone satinato satin brass
ORL	oro lucido glossy gold
CUS	rame satinato satin copper

MATERIALE: ZAMA / MATERIAL: ZAMAK

FINITURE DISPONIBILI / AVAILABLE FINISHING:

OTS	ottone satinato satin brass
ORL	oro lucido glossy gold
CUS	rame satinato satin copper
PES	peltro pewter
NLL	nikel lucido glossy nickel



CR040+CS003L

180x570 mm



CR040+CS012

180x570 mm

MATERIALE: ZAMA / MATERIAL: ZAMAK

FINITURE DISPONIBILI / AVAILABLE FINISHING:

OTS ottone satinato
satin brass

MATERIALE: ZAMA / MATERIAL: ZAMAK

FINITURE DISPONIBILI / AVAILABLE FINISHING:

OTS ottone satinato
satin brass

ORL oro lucido
glossy gold

CUS rame satinato
satin copper

PES peltro
pewter

NLL nikel lucido
glossy nickel



CR041+CS002L

165x525 mm

MATERIALE: ZAMA / MATERIAL: ZAMAK

FINITURE DISPONIBILI / AVAILABLE FINISHING:

OTS	ottone satinato satin brass
ORL	oro lucido glossy gold
CUS	rame satinato satin copper
PES	peltro pewter
NLL	nikel lucido glossy nickel



CR042

165x540 mm

MATERIALE: ZAMA / MATERIAL: ZAMAK

FINITURE DISPONIBILI / AVAILABLE FINISHING:

OTS	ottone satinato satin brass
ORL	oro lucido glossy gold
CUS	rame satinato satin copper



CR148

170x640 mm

CR154

165x547 mm

MATERIALE: METALLO / MATERIAL: METAL

FINITURE DISPONIBILI / AVAILABLE FINISHING:

OTS ottone satinato
satin brass

ORL oro lucido
glossy gold

MATERIALE: METALLO E ZAMA / MATERIAL: METAL & ZAMAK

FINITURE DISPONIBILI / AVAILABLE FINISHING:

OTS ottone satinato
satin brass

ORL oro lucido
glossy gold

CUS rame satinato
satin copper

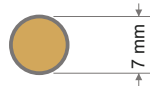
CR152+CS006

160X665 mm

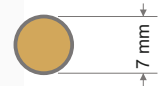
CR152+CS010

170X665 mm

MATERIALE: METALLO E ZAMA / MATERIAL: METAL & ZAMAK

FINITURE DISPONIBILI / AVAILABLE FINISHING:

NLL	<i>nikel lucido glossy nickel</i>	NLL	<i>nikel lucido glossy nickel</i>
ORL	<i>oro lucido glossy gold</i>	ORL	<i>oro lucido glossy gold</i>
OTS	<i>ottone satinato satin brass</i>	OTS	<i>ottone satinato satin brass</i>
CUS	<i>rame satinato satin copper</i>	CUS	<i>rame satinato satin copper</i>

MATERIALE: METALLO E ZAMA / MATERIAL: METAL & ZAMAK

FINITURE DISPONIBILI / AVAILABLE FINISHING:

NLL	<i>nikel lucido glossy nickel</i>	NLL	<i>nikel lucido glossy nickel</i>
ORL	<i>oro lucido glossy gold</i>	ORL	<i>oro lucido glossy gold</i>
OTS	<i>ottone satinato satin brass</i>	OTS	<i>ottone satinato satin brass</i>
CUS	<i>rame satinato satin copper</i>	CUS	<i>rame satinato satin copper</i>

Croce magnetica componibile con svariato rose di differente colore



FC1778



FC1783



FC1777



FC1780



FC1779



FC1784



FC1781



FC1785



CR160+FC1782

160x530 mm



CR160

FC1782

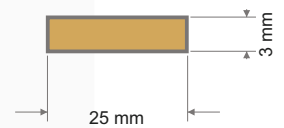

CR160	FC17##												
MATERIALE: METALLO / MATERIAL: METAL	MATERIALE: METALLO / MATERIAL: METAL												
FINITURE DISPONIBILI / AVAILABLE FINISHING:	FINITURE DISPONIBILI / AVAILABLE FINISHING:												
<p>ORL oro lucido glossy gold</p>	<table border="0"> <tr> <td>FC1780AGL rosa blu blue rose</td> <td>FC1777AGL rosa rosa pink rose</td> </tr> <tr> <td>FC1781AGL rosa gialla yellow rose</td> <td>FC1778ORL rosa rosa pink rose</td> </tr> <tr> <td>FC1782ORL rosa rossa red rose</td> <td></td> </tr> <tr> <td>FC1783ORL rosa bianca white rose</td> <td></td> </tr> <tr> <td>FC1784AGL rosa bianca white rose</td> <td></td> </tr> <tr> <td>FC1785AGL rosa rossa red rose</td> <td></td> </tr> </table>	FC1780AGL rosa blu blue rose	FC1777AGL rosa rosa pink rose	FC1781AGL rosa gialla yellow rose	FC1778ORL rosa rosa pink rose	FC1782ORL rosa rossa red rose		FC1783ORL rosa bianca white rose		FC1784AGL rosa bianca white rose		FC1785AGL rosa rossa red rose	
FC1780AGL rosa blu blue rose	FC1777AGL rosa rosa pink rose												
FC1781AGL rosa gialla yellow rose	FC1778ORL rosa rosa pink rose												
FC1782ORL rosa rossa red rose													
FC1783ORL rosa bianca white rose													
FC1784AGL rosa bianca white rose													
FC1785AGL rosa rossa red rose													

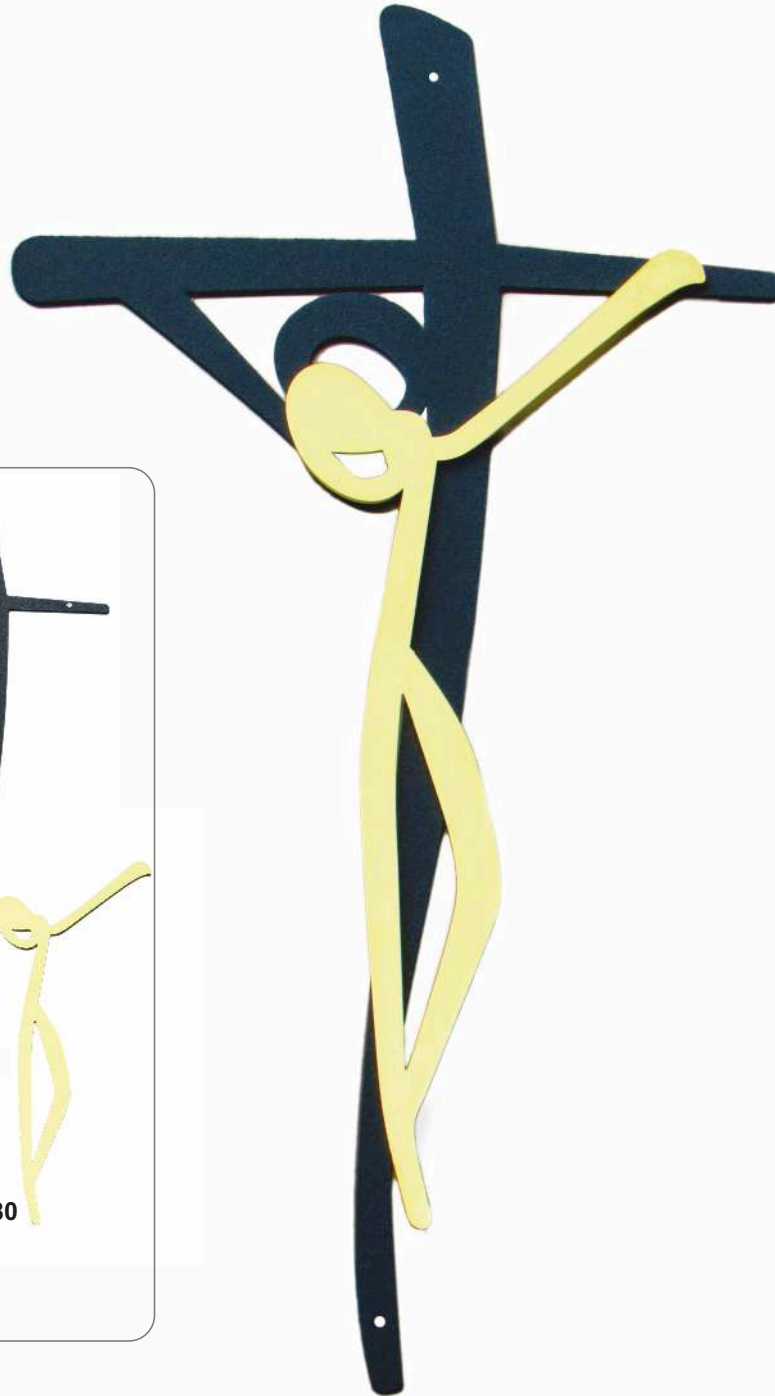





CR180

CS180

CR180#+CS180#

230 x 460 mm

CR180	CS180
MATERIALE: METALLO / MATERIAL: METAL	MATERIALE: METALLO / MATERIAL: METAL
FINITURE DISPONIBILI /AVAILABLE FINISHING:	FINITURE DISPONIBILI /AVAILABLE FINISHING:
<p>NLL  acciaio lucido glossy steel</p> <p>ANT  antracite anthracite</p>	<p>NLL  acciaio lucido glossy steel</p> <p>ANT  antracite anthracite</p>



CR3001

160x530 mm

MATERIALE: ALLUMINIO / MATERIAL: ALLUMINIUM

FINITURE DISPONIBILI / AVAILABLE FINISHING:

OTS	ottone satinato satin brass
ORL	oro lucido glossy gold

Croce magnetica componibile con svariato rose di differente colore



FC1778



FC1783



FC1777



FC1780



FC1779



FC1784



FC1781



FC1785



CR471+FC1782

560 x 200 mm



CR471

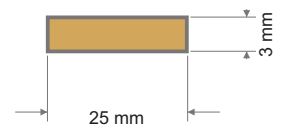

CR471	FC17##
MATERIALE: PLEXIGLASS / MATERIAL: PLEXIGLASS	MATERIALE: METALLO / MATERIAL: METAL
FINITURE DISPONIBILI / AVAILABLE FINISHING:	FINITURE DISPONIBILI / AVAILABLE FINISHING:
<p>ORL oro lucido glossy gold</p>	<p>FC1780AGL rosa blu blue rose</p> <p>FC1781AGL rosa gialla yellow rose</p> <p>FC1782ORL rosa rossa red rose</p> <p>FC1783ORL rosa bianca white rose</p> <p>FC1784AGL rosa bianca white rose</p> <p>FC1785AGL rosa rossa red rose</p> <p>FC1777AGL rosa rosa pink rose</p> <p>FC1778ORL rosa rosa pink rose</p>

Croce magnetica componibile con svariato rose di differente colore



CR472+FC1782

530 x 160 mm

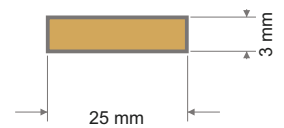

CR472	FC17##
MATERIALE: PLEXIGLASS / MATERIAL: PLEXIGLASS	MATERIALE: METALLO / MATERIAL: METAL
FINITURE DISPONIBILI / AVAILABLE FINISHING: ORL oro lucido / glossy gold	FINITURE DISPONIBILI / AVAILABLE FINISHING: FC1780AGL rosa blu / blue rose FC1781AGL rosa gialla / yellow rose FC1782ORL rosa rossa / red rose FC1783ORL rosa bianca / white rose FC1784AGL rosa bianca / white rose FC1785AGL rosa rossa / red rose FC1777AGL rosa rosa / pink rose FC1778ORL rosa rosa / pink rose

Croce magnetica componibile con svariate rose di differente colore



CR474+FC1782

530 x 160 mm

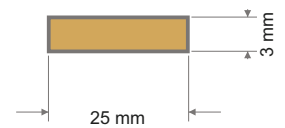

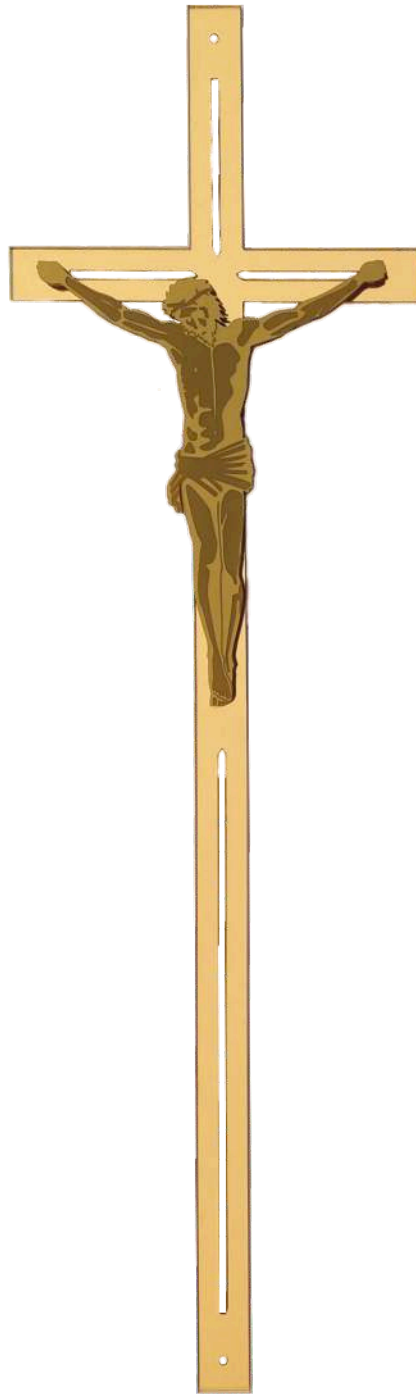

CR474	FC17##
MATERIALE: PLEXIGLASS / MATERIAL: PLEXIGLASS	MATERIALE: METALLO / MATERIAL: METAL
FINITURE DISPONIBILI / AVAILABLE FINISHING: ORL oro lucido / glossy gold	FINITURE DISPONIBILI / AVAILABLE FINISHING: FC1780AGL rosa blu / blue rose FC1781AGL rosa gialla / yellow rose FC1782ORL rosa rossa / red rose FC1783ORL rosa bianca / white rose FC1784AGL rosa bianca / white rose FC1785AGL rosa rossa / red rose FC1777AGL rosa rosa / pink rose FC1778ORL rosa rosa / pink rose

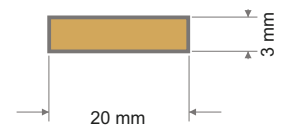

CR473+CS420

525x155 - 3 mm

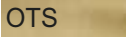

CR473	CS420
MATERIALE: PLEXIGLASS / MATERIAL: PLEXIGLASS	MATERIALE: PLEXIGLASS / MATERIAL: PLEXIGLASS
FINITURE DISPONIBILI /AVAILABLE FINISHING:	FINITURE DISPONIBILI /AVAILABLE FINISHING:
<p>ORL  <i>oro lucido</i> <i>glossy gold</i></p> <p>OTS  <i>ottone satinato</i> <i>satin brass</i></p>	<p>OTS  <i>ottone satinato</i> <i>satin brass</i></p>

Croce magnetica componibile con svariata rose di differente colore



CR490+FC1782

180x465 - 5 mm

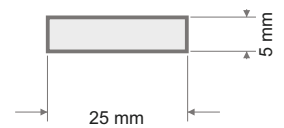

CR490	FC17##																		
MATERIALE: PLEXIGLASS / MATERIAL: PLEXIGLASS	MATERIALE: METALLO / MATERIAL: METAL																		
FINITURE DISPONIBILI / AVAILABLE FINISHING:	FINITURE DISPONIBILI / AVAILABLE FINISHING:																		
plexiglass	<table style="width: 100%; border: none;"> <tr> <td style="width: 50%; border: none;"> <table style="width: 100%; border: none;"> <tr> <td style="background-color: #cccccc; padding: 2px;">FC1780AGL</td> <td style="padding: 2px;"><i>rosa blu</i> <i>blue rose</i></td> </tr> <tr> <td style="background-color: #cccccc; padding: 2px;">FC1781AGL</td> <td style="padding: 2px;"><i>rosa gialla</i> <i>yellow rose</i></td> </tr> <tr> <td style="background-color: #ffff00; padding: 2px;">FC1782ORL</td> <td style="padding: 2px;"><i>rosa rossa</i> <i>red rose</i></td> </tr> <tr> <td style="background-color: #ffff00; padding: 2px;">FC1783ORL</td> <td style="padding: 2px;"><i>rosa bianca</i> <i>white rose</i></td> </tr> <tr> <td style="background-color: #cccccc; padding: 2px;">FC1784AGL</td> <td style="padding: 2px;"><i>rosa bianca</i> <i>white rose</i></td> </tr> <tr> <td style="background-color: #cccccc; padding: 2px;">FC1785AGL</td> <td style="padding: 2px;"><i>rosa rossa</i> <i>red rose</i></td> </tr> </table> </td> <td style="width: 50%; border: none;"> <table style="width: 100%; border: none;"> <tr> <td style="background-color: #cccccc; padding: 2px;">FC1777AGL</td> <td style="padding: 2px;"><i>rosa rosa</i> <i>pink rose</i></td> </tr> <tr> <td style="background-color: #ffff00; padding: 2px;">FC1778ORL</td> <td style="padding: 2px;"><i>rosa rosa</i> <i>pink rose</i></td> </tr> </table> </td> </tr> </table>	<table style="width: 100%; border: none;"> <tr> <td style="background-color: #cccccc; padding: 2px;">FC1780AGL</td> <td style="padding: 2px;"><i>rosa blu</i> <i>blue rose</i></td> </tr> <tr> <td style="background-color: #cccccc; padding: 2px;">FC1781AGL</td> <td style="padding: 2px;"><i>rosa gialla</i> <i>yellow rose</i></td> </tr> <tr> <td style="background-color: #ffff00; padding: 2px;">FC1782ORL</td> <td style="padding: 2px;"><i>rosa rossa</i> <i>red rose</i></td> </tr> <tr> <td style="background-color: #ffff00; padding: 2px;">FC1783ORL</td> <td style="padding: 2px;"><i>rosa bianca</i> <i>white rose</i></td> </tr> <tr> <td style="background-color: #cccccc; padding: 2px;">FC1784AGL</td> <td style="padding: 2px;"><i>rosa bianca</i> <i>white rose</i></td> </tr> <tr> <td style="background-color: #cccccc; padding: 2px;">FC1785AGL</td> <td style="padding: 2px;"><i>rosa rossa</i> <i>red rose</i></td> </tr> </table>	FC1780AGL	<i>rosa blu</i> <i>blue rose</i>	FC1781AGL	<i>rosa gialla</i> <i>yellow rose</i>	FC1782ORL	<i>rosa rossa</i> <i>red rose</i>	FC1783ORL	<i>rosa bianca</i> <i>white rose</i>	FC1784AGL	<i>rosa bianca</i> <i>white rose</i>	FC1785AGL	<i>rosa rossa</i> <i>red rose</i>	<table style="width: 100%; border: none;"> <tr> <td style="background-color: #cccccc; padding: 2px;">FC1777AGL</td> <td style="padding: 2px;"><i>rosa rosa</i> <i>pink rose</i></td> </tr> <tr> <td style="background-color: #ffff00; padding: 2px;">FC1778ORL</td> <td style="padding: 2px;"><i>rosa rosa</i> <i>pink rose</i></td> </tr> </table>	FC1777AGL	<i>rosa rosa</i> <i>pink rose</i>	FC1778ORL	<i>rosa rosa</i> <i>pink rose</i>
<table style="width: 100%; border: none;"> <tr> <td style="background-color: #cccccc; padding: 2px;">FC1780AGL</td> <td style="padding: 2px;"><i>rosa blu</i> <i>blue rose</i></td> </tr> <tr> <td style="background-color: #cccccc; padding: 2px;">FC1781AGL</td> <td style="padding: 2px;"><i>rosa gialla</i> <i>yellow rose</i></td> </tr> <tr> <td style="background-color: #ffff00; padding: 2px;">FC1782ORL</td> <td style="padding: 2px;"><i>rosa rossa</i> <i>red rose</i></td> </tr> <tr> <td style="background-color: #ffff00; padding: 2px;">FC1783ORL</td> <td style="padding: 2px;"><i>rosa bianca</i> <i>white rose</i></td> </tr> <tr> <td style="background-color: #cccccc; padding: 2px;">FC1784AGL</td> <td style="padding: 2px;"><i>rosa bianca</i> <i>white rose</i></td> </tr> <tr> <td style="background-color: #cccccc; padding: 2px;">FC1785AGL</td> <td style="padding: 2px;"><i>rosa rossa</i> <i>red rose</i></td> </tr> </table>	FC1780AGL	<i>rosa blu</i> <i>blue rose</i>	FC1781AGL	<i>rosa gialla</i> <i>yellow rose</i>	FC1782ORL	<i>rosa rossa</i> <i>red rose</i>	FC1783ORL	<i>rosa bianca</i> <i>white rose</i>	FC1784AGL	<i>rosa bianca</i> <i>white rose</i>	FC1785AGL	<i>rosa rossa</i> <i>red rose</i>	<table style="width: 100%; border: none;"> <tr> <td style="background-color: #cccccc; padding: 2px;">FC1777AGL</td> <td style="padding: 2px;"><i>rosa rosa</i> <i>pink rose</i></td> </tr> <tr> <td style="background-color: #ffff00; padding: 2px;">FC1778ORL</td> <td style="padding: 2px;"><i>rosa rosa</i> <i>pink rose</i></td> </tr> </table>	FC1777AGL	<i>rosa rosa</i> <i>pink rose</i>	FC1778ORL	<i>rosa rosa</i> <i>pink rose</i>		
FC1780AGL	<i>rosa blu</i> <i>blue rose</i>																		
FC1781AGL	<i>rosa gialla</i> <i>yellow rose</i>																		
FC1782ORL	<i>rosa rossa</i> <i>red rose</i>																		
FC1783ORL	<i>rosa bianca</i> <i>white rose</i>																		
FC1784AGL	<i>rosa bianca</i> <i>white rose</i>																		
FC1785AGL	<i>rosa rossa</i> <i>red rose</i>																		
FC1777AGL	<i>rosa rosa</i> <i>pink rose</i>																		
FC1778ORL	<i>rosa rosa</i> <i>pink rose</i>																		

Croce magnetica componibile con svariato rose di differente colore

CR491+FC178#

160x530 - 5 mm

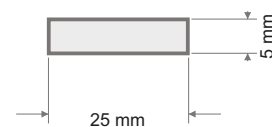

CR491	FC17##																		
MATERIALE: PLEXIGLASS / MATERIAL: PLEXIGLASS	MATERIALE: METALLO / MATERIAL: METAL																		
FINITURE DISPONIBILI / AVAILABLE FINISHING:	FINITURE DISPONIBILI / AVAILABLE FINISHING:																		
plexiglass	<table style="width: 100%; border: none;"> <tr> <td style="width: 50%; vertical-align: top;"> <table border="0"> <tr><td style="background-color: #cccccc; padding: 2px;">FC1780AGL</td><td style="padding: 2px;"><i>rosa blu</i> <i>blue rose</i></td></tr> <tr><td style="background-color: #cccccc; padding: 2px;">FC1781AGL</td><td style="padding: 2px;"><i>rosa gialla</i> <i>yellow rose</i></td></tr> <tr><td style="background-color: #ffff00; padding: 2px;">FC1782ORL</td><td style="padding: 2px;"><i>rosa rossa</i> <i>red rose</i></td></tr> <tr><td style="background-color: #ffff00; padding: 2px;">FC1783ORL</td><td style="padding: 2px;"><i>rosa bianca</i> <i>white rose</i></td></tr> <tr><td style="background-color: #cccccc; padding: 2px;">FC1784AGL</td><td style="padding: 2px;"><i>rosa bianca</i> <i>white rose</i></td></tr> <tr><td style="background-color: #cccccc; padding: 2px;">FC1785AGL</td><td style="padding: 2px;"><i>rosa rossa</i> <i>red rose</i></td></tr> </table> </td> <td style="width: 50%; vertical-align: top;"> <table border="0"> <tr><td style="background-color: #cccccc; padding: 2px;">FC1777AGL</td><td style="padding: 2px;"><i>rosa rosa</i> <i>pink rose</i></td></tr> <tr><td style="background-color: #ffff00; padding: 2px;">FC1778ORL</td><td style="padding: 2px;"><i>rosa rosa</i> <i>pink rose</i></td></tr> </table> </td> </tr> </table>	<table border="0"> <tr><td style="background-color: #cccccc; padding: 2px;">FC1780AGL</td><td style="padding: 2px;"><i>rosa blu</i> <i>blue rose</i></td></tr> <tr><td style="background-color: #cccccc; padding: 2px;">FC1781AGL</td><td style="padding: 2px;"><i>rosa gialla</i> <i>yellow rose</i></td></tr> <tr><td style="background-color: #ffff00; padding: 2px;">FC1782ORL</td><td style="padding: 2px;"><i>rosa rossa</i> <i>red rose</i></td></tr> <tr><td style="background-color: #ffff00; padding: 2px;">FC1783ORL</td><td style="padding: 2px;"><i>rosa bianca</i> <i>white rose</i></td></tr> <tr><td style="background-color: #cccccc; padding: 2px;">FC1784AGL</td><td style="padding: 2px;"><i>rosa bianca</i> <i>white rose</i></td></tr> <tr><td style="background-color: #cccccc; padding: 2px;">FC1785AGL</td><td style="padding: 2px;"><i>rosa rossa</i> <i>red rose</i></td></tr> </table>	FC1780AGL	<i>rosa blu</i> <i>blue rose</i>	FC1781AGL	<i>rosa gialla</i> <i>yellow rose</i>	FC1782ORL	<i>rosa rossa</i> <i>red rose</i>	FC1783ORL	<i>rosa bianca</i> <i>white rose</i>	FC1784AGL	<i>rosa bianca</i> <i>white rose</i>	FC1785AGL	<i>rosa rossa</i> <i>red rose</i>	<table border="0"> <tr><td style="background-color: #cccccc; padding: 2px;">FC1777AGL</td><td style="padding: 2px;"><i>rosa rosa</i> <i>pink rose</i></td></tr> <tr><td style="background-color: #ffff00; padding: 2px;">FC1778ORL</td><td style="padding: 2px;"><i>rosa rosa</i> <i>pink rose</i></td></tr> </table>	FC1777AGL	<i>rosa rosa</i> <i>pink rose</i>	FC1778ORL	<i>rosa rosa</i> <i>pink rose</i>
<table border="0"> <tr><td style="background-color: #cccccc; padding: 2px;">FC1780AGL</td><td style="padding: 2px;"><i>rosa blu</i> <i>blue rose</i></td></tr> <tr><td style="background-color: #cccccc; padding: 2px;">FC1781AGL</td><td style="padding: 2px;"><i>rosa gialla</i> <i>yellow rose</i></td></tr> <tr><td style="background-color: #ffff00; padding: 2px;">FC1782ORL</td><td style="padding: 2px;"><i>rosa rossa</i> <i>red rose</i></td></tr> <tr><td style="background-color: #ffff00; padding: 2px;">FC1783ORL</td><td style="padding: 2px;"><i>rosa bianca</i> <i>white rose</i></td></tr> <tr><td style="background-color: #cccccc; padding: 2px;">FC1784AGL</td><td style="padding: 2px;"><i>rosa bianca</i> <i>white rose</i></td></tr> <tr><td style="background-color: #cccccc; padding: 2px;">FC1785AGL</td><td style="padding: 2px;"><i>rosa rossa</i> <i>red rose</i></td></tr> </table>	FC1780AGL	<i>rosa blu</i> <i>blue rose</i>	FC1781AGL	<i>rosa gialla</i> <i>yellow rose</i>	FC1782ORL	<i>rosa rossa</i> <i>red rose</i>	FC1783ORL	<i>rosa bianca</i> <i>white rose</i>	FC1784AGL	<i>rosa bianca</i> <i>white rose</i>	FC1785AGL	<i>rosa rossa</i> <i>red rose</i>	<table border="0"> <tr><td style="background-color: #cccccc; padding: 2px;">FC1777AGL</td><td style="padding: 2px;"><i>rosa rosa</i> <i>pink rose</i></td></tr> <tr><td style="background-color: #ffff00; padding: 2px;">FC1778ORL</td><td style="padding: 2px;"><i>rosa rosa</i> <i>pink rose</i></td></tr> </table>	FC1777AGL	<i>rosa rosa</i> <i>pink rose</i>	FC1778ORL	<i>rosa rosa</i> <i>pink rose</i>		
FC1780AGL	<i>rosa blu</i> <i>blue rose</i>																		
FC1781AGL	<i>rosa gialla</i> <i>yellow rose</i>																		
FC1782ORL	<i>rosa rossa</i> <i>red rose</i>																		
FC1783ORL	<i>rosa bianca</i> <i>white rose</i>																		
FC1784AGL	<i>rosa bianca</i> <i>white rose</i>																		
FC1785AGL	<i>rosa rossa</i> <i>red rose</i>																		
FC1777AGL	<i>rosa rosa</i> <i>pink rose</i>																		
FC1778ORL	<i>rosa rosa</i> <i>pink rose</i>																		



CR485

140x440 mm

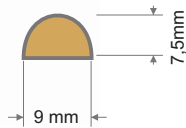

CR489+CS418

140x450 mm

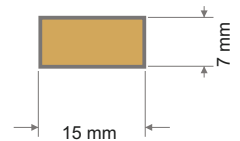

MATERIALE: PLASTICA / MATERIAL: PLASTIC

FINITURE DISPONIBILI / AVAILABLE FINISHING:

- ORL** oro lucido
glossy gold
- CUS** rame satinato
satin copper

MATERIALE: PLASTICA / MATERIAL: PLASTIC

FINITURE DISPONIBILI / AVAILABLE FINISHING:

- ORL** oro lucido
glossy gold

CRISTI

CHRIST BODIES

ZORSOL



CS002

180 mm

<i>MATERIALE: ZAMA / MATERIAL: ZAMAK</i>	
<i>FINITURE DISPONIBILI / AVAILABLE FINISHING:</i>	
OTS	<i>ottone satinato satin brass</i>
ORL	<i>oro lucido glossy gold</i>
CUS	<i>rame satinato satin copper</i>
NLS	<i>finitura mista: satinata e lucida satin and glossy finishing</i>
NLL	<i>nikel lucido glossy nikel</i>

CS003

240 mm

<i>MATERIALE: ZAMA / MATERIAL: ZAMAK</i>	
<i>FINITURE DISPONIBILI / AVAILABLE FINISHING:</i>	
OTS	<i>ottone satinato satin brass</i>
ORL	<i>oro lucido glossy gold</i>
CUS	<i>rame satinato satin copper</i>
NLL	<i>nikel lucido glossy nikel</i>

CS004

240 mm

MATERIALE: ZAMA / MATERIAL: ZAMAK

FINITURE DISPONIBILI / AVAILABLE FINISHING:

OTS	ottone satinato satin brass
ORL	oro lucido glossy gold
CUS	rame satinato satin copper

CS006

320 mm

MATERIALE: ZAMA / MATERIAL: ZAMAK

FINITURE DISPONIBILI / AVAILABLE FINISHING:

OTS	ottone satinato satin brass
ORL	oro lucido glossy gold
CUS	rame satinato satin copper
NLL	nikel lucido glossy nikel

CS010

260 mm

<i>MATERIALE: ZAMA / MATERIAL: ZAMAK</i>	
<i>FINITURE DISPONIBILI / AVAILABLE FINISHING:</i>	
OTS	<i>ottone satinato satin brass</i>
ORL	<i>oro lucido glossy gold</i>
CUS	<i>rame satinato satin copper</i>
NLL	<i>nikel lucido glossy nikel</i>

CS011

210 mm

<i>MATERIALE: ZAMA / MATERIAL: ZAMAK</i>	
<i>FINITURE DISPONIBILI / AVAILABLE FINISHING:</i>	
OTS	<i>ottone satinato satin brass</i>
ORL	<i>oro lucido glossy gold</i>
CUS	<i>rame satinato satin copper</i>
NLL	<i>nikel lucido glossy nikel</i>



CS012

245 mm

MATERIALE: ZAMA / MATERIAL: ZAMAK

FINITURE DISPONIBILI /AVAILABLE FINISHING:

OTS	<i>ottone satinato</i> satin brass
ORL	<i>oro lucido</i> glossy gold
CUS	<i>rame satinato</i> satin copper
NLL	<i>nikel lucido</i> glossy nickel
PES	<i>peltro</i> pewter

FINITURA COFANI

COFFINS FINISH

ZORSOL



FC0200
h35 mm

MATERIALE: ZAMA / MATERIAL: ZAMAK	
FINITURE DISPONIBILI /AVAILABLE FINISHING:	DESCRIZIONE: DESCRIPTION:
OTS <i>ottone satinato satin brass</i>	PIEDE FOOT
ORL <i>oro lucido glossy gold</i>	
CUS <i>rame satinato satin copper</i>	
NLL <i>nikel lucido glossy nickel</i>	

infante / enfant
FC0206
h30 mm

MATERIALE: ZAMA / MATERIAL: ZAMAK	
FINITURE DISPONIBILI /AVAILABLE FINISHING:	DESCRIZIONE: DESCRIPTION:
ORL <i>oro lucido glossy gold</i>	PIEDE FOOT

FC1204
h25 mm

MATERIALE: METALLO / MATERIAL: METAL	
FINITURE DISPONIBILI /AVAILABLE FINISHING:	DESCRIZIONE: DESCRIPTION:
OTS <i>ottone satinato satin brass</i>	PIEDE FOOT
ORL <i>oro lucido glossy gold</i>	
CUS <i>rame satinato satin copper</i>	

FC4209
h40mm

MATERIALE: PLASTICA / MATERIAL: PLASTIC	
FINITURE DISPONIBILI /AVAILABLE FINISHING:	DESCRIZIONE: DESCRIPTION:
ORL <i>oro lucido glossy gold</i>	PIEDE FOOT
NO <i>noce walnut</i>	
MO <i>mogano mahogany</i>	
RO <i>rovere oak</i>	

FC2903
h15 mm - Ø13 mm

<i>MATERIALE: OTTONE / MATERIAL: BRASS</i>	
<i>FINITURE DISPONIBILI /AVAILABLE FINISHING:</i>	<i>DESCRIZIONE: DESCRIPTION:</i>
ORL <i>oro lucido glossy gold</i>	<i>MINUTERIA PARTS</i>

FC2911
Ø14 mm

<i>MATERIALE: OTTONE / MATERIAL: BRASS</i>	
<i>FINITURE DISPONIBILI /AVAILABLE FINISHING:</i>	<i>DESCRIZIONE: DESCRIPTION:</i>
CUS <i>rame satinato satin copper</i>	<i>MINUTERIA PARTS</i>
FML <i>finitura lucida glossy finishing</i>	
NLL <i>nikel lucido glossy nikel</i>	

FC2913
Ø15 mm

<i>MATERIALE: OTTONE / MATERIAL: BRASS</i>	
<i>FINITURE DISPONIBILI /AVAILABLE FINISHING:</i>	<i>DESCRIZIONE: DESCRIPTION:</i>
FML <i>finitura lucida glossy finishing</i>	<i>MINUTERIA PARTS</i>

FC2914
Ø14 mm

<i>MATERIALE: OTTONE / MATERIAL: BRASS</i>	
<i>FINITURE DISPONIBILI /AVAILABLE FINISHING:</i>	<i>DESCRIZIONE: DESCRIPTION:</i>
FML <i>finitura lucida glossy finishing</i>	<i>MINUTERIA PARTS</i>
FMS <i>finitura satinata satin finishing</i>	
CUS <i>rame satinato satin copper</i>	
NLL <i>nikel lucido glossy nikel</i>	
NLS <i>finitura mista: satinata e lucida satin and glossy finishing</i>	

FC2915

30x35 mm

<i>MATERIALE: OTTONE / MATERIAL: BRASS</i>	
<i>FINITURE DISPONIBILI / AVAILABLE FINISHING:</i>	<i>DESCRIZIONE: DESCRIPTION:</i>
CUS rame satinato satin copper	MINUTERIA PARTS
FML finitura lucida glossy finishing	
NLL nikel lucido glossy nikel	

Gemma con fissaggio calamitato
FC2916

27x30 mm

<i>MATERIALE: OTTONE / MATERIAL: BRASS</i>	
<i>FINITURE DISPONIBILI / AVAILABLE FINISHING:</i>	<i>DESCRIZIONE: DESCRIPTION:</i>
FML finitura lucida glossy finishing	MINUTERIA PARTS

FC0928

40x45 mm

<i>MATERIALE: OTTONE / MATERIAL: BRASS</i>	
<i>FINITURE DISPONIBILI / AVAILABLE FINISHING:</i>	<i>DESCRIZIONE: DESCRIPTION:</i>
OTS ottone satinato satin brass	MINUTERIA PARTS
ORL oro lucido glossy gold	
CUS rame satinato satin copper	
NLL nikel lucido glossy nikel	

FC0938

49x40 mm

<i>MATERIALE: ZAMA / MATERIAL: ZAMAK</i>	
<i>FINITURE DISPONIBILI / AVAILABLE FINISHING:</i>	<i>DESCRIZIONE: DESCRIPTION:</i>
OTS ottone satinato satin brass	MINUTERIA PARTS
ORL oro lucido glossy gold	

FC1934
h12 - Ø20 mm

<i>MATERIALE: ZAMA / MATERIAL: ZAMAK</i>	
<i>FINITURE DISPONIBILI /AVAILABLE FINISHING:</i>	<i>DESCRIZIONE: DESCRIPTION:</i>
OTS ottone satinato satin brass	CACHE VIS
ORL oro lucido glossy gold	
NLS finitura mista: satinata e lucida satin and glossy finishing	

FC0930
105x20 mm

<i>MATERIALE: ZAMA / MATERIAL: ZAMAK</i>	
<i>FINITURE DISPONIBILI /AVAILABLE FINISHING:</i>	<i>DESCRIZIONE: DESCRIPTION:</i>
OTS ottone satinato satin brass	CACHE VIS
ORL oro lucido glossy gold	

VI19## TGS

<i>MATERIALE: METALLO / MATERIAL: METAL</i>	
<i>FINITURE DISPONIBILI /AVAILABLE FINISHING:</i>	<i>DESCRIZIONE: DESCRIPTION:</i>
OTS ottone satinato satin brass	VITI SCREW #16: 4.5x25mm #17: 4.5x30mm #18: 4.5x40mm #19: 4.5x45mm #20: 4.5x50mm #21: 4.5x60mm #22: 4.5x70mm #23: 4.5x35mm
CUS rame satinato satin copper	

PT0886
180 x 125 x 75 mm

<i>MATERIALE: LEGNO / MATERIAL: WOOD</i>	
<i>FINITURE DISPONIBILI /AVAILABLE FINISHING:</i>	<i>DESCRIZIONE: DESCRIPTION:</i>
RO rovere oak	MINUTERIA PARTS

FC0752
h55 mm

MATERIALE: ZAMA / MATERIAL: ZAMAK	
FINITURE DISPONIBILI /AVAILABLE FINISHING:	DESCRIZIONE: DESCRIPTION:
OTS ottone satinato satin brass	TIRE FOND
ORL oro lucido glossy gold	
CUS rame satinato satin copper	
NLL nikel lucido glossy nikel	

FC0753
h55 mm

MATERIALE: ZAMA / MATERIAL: ZAMAK	
FINITURE DISPONIBILI /AVAILABLE FINISHING:	DESCRIZIONE: DESCRIPTION:
OTS ottone satinato satin brass	TIRE FOND
ORL oro lucido glossy gold	
CUS rame satinato satin copper	
NLL nikel lucido glossy nikel	

infante / enfant
FC0755
70x90 mm

MATERIALE: ZAMA / MATERIAL: ZAMAK	
FINITURE DISPONIBILI /AVAILABLE FINISHING:	DESCRIZIONE: DESCRIPTION:
ORL oro lucido glossy gold	DECORAZIONE DECORATION

FC4501
125x145 mm

MATERIALE: PLASTICA / MATERIAL: PLASTIC	
FINITURE DISPONIBILI /AVAILABLE FINISHING:	DESCRIZIONE: DESCRIPTION:
OTS ottone satinato satin brass	DECORAZIONE DECORATION
ORL oro lucido glossy gold	
CUS rame satinato satin copper	

FC1912

Ø5 mm - 25 mm

MATERIALE: METALLO / MATERIAL: METAL							
FINITURE DISPONIBILI / AVAILABLE FINISHING: <table border="0"> <tr> <td style="background-color: #FFD700; padding: 2px;">ORL</td> <td style="padding: 2px;"><i>oro lucido glossy gold</i></td> </tr> <tr> <td style="background-color: #A52A2A; padding: 2px;">CUS</td> <td style="padding: 2px;"><i>rame satinato satin copper</i></td> </tr> <tr> <td style="background-color: #808080; padding: 2px;">NLL</td> <td style="padding: 2px;"><i>nikel lucido glossy nikel</i></td> </tr> </table>	ORL	<i>oro lucido glossy gold</i>	CUS	<i>rame satinato satin copper</i>	NLL	<i>nikel lucido glossy nikel</i>	DESCRIZIONE: DESCRIPTION: MINUTERIA PARTS
ORL	<i>oro lucido glossy gold</i>						
CUS	<i>rame satinato satin copper</i>						
NLL	<i>nikel lucido glossy nikel</i>						

FC1908

Ø9 - 16 mm

MATERIALE: METALLO / MATERIAL: METAL							
FINITURE DISPONIBILI / AVAILABLE FINISHING: <table border="0"> <tr> <td style="background-color: #FFD700; padding: 2px;">ORL</td> <td style="padding: 2px;"><i>oro lucido glossy gold</i></td> </tr> <tr> <td style="background-color: #A52A2A; padding: 2px;">CUS</td> <td style="padding: 2px;"><i>rame satinato satin copper</i></td> </tr> <tr> <td style="background-color: #808080; padding: 2px;">NLL</td> <td style="padding: 2px;"><i>nikel lucido glossy nikel</i></td> </tr> </table>	ORL	<i>oro lucido glossy gold</i>	CUS	<i>rame satinato satin copper</i>	NLL	<i>nikel lucido glossy nikel</i>	DESCRIZIONE: DESCRIPTION: MINUTERIA PARTS
ORL	<i>oro lucido glossy gold</i>						
CUS	<i>rame satinato satin copper</i>						
NLL	<i>nikel lucido glossy nikel</i>						

FC1914

Ø24 - 23 mm

MATERIALE: METALLO / MATERIAL: METAL							
FINITURE DISPONIBILI / AVAILABLE FINISHING: <table border="0"> <tr> <td style="background-color: #FFD700; padding: 2px;">ORL</td> <td style="padding: 2px;"><i>oro lucido glossy gold</i></td> </tr> <tr> <td style="background-color: #B8860B; padding: 2px;">OTS</td> <td style="padding: 2px;"><i>ottone satinato satin brass</i></td> </tr> <tr> <td style="background-color: #A52A2A; padding: 2px;">CUS</td> <td style="padding: 2px;"><i>rame satinato satin copper</i></td> </tr> </table>	ORL	<i>oro lucido glossy gold</i>	OTS	<i>ottone satinato satin brass</i>	CUS	<i>rame satinato satin copper</i>	DESCRIZIONE: DESCRIPTION: MINUTERIA PARTS
ORL	<i>oro lucido glossy gold</i>						
OTS	<i>ottone satinato satin brass</i>						
CUS	<i>rame satinato satin copper</i>						

FC1904

Ø24 - 10 mm

MATERIALE: METALLO / MATERIAL: METAL					
FINITURE DISPONIBILI / AVAILABLE FINISHING: <table border="0"> <tr> <td style="background-color: #FFD700; padding: 2px;">ORL</td> <td style="padding: 2px;"><i>oro lucido glossy gold</i></td> </tr> <tr> <td style="background-color: #A52A2A; padding: 2px;">CUS</td> <td style="padding: 2px;"><i>rame satinato satin copper</i></td> </tr> </table>	ORL	<i>oro lucido glossy gold</i>	CUS	<i>rame satinato satin copper</i>	DESCRIZIONE: DESCRIPTION: MINUTERIA PARTS
ORL	<i>oro lucido glossy gold</i>				
CUS	<i>rame satinato satin copper</i>				

FC1910

Ø22 mm

MATERIALE: METALLO / MATERIAL: METAL	
FINITURE DISPONIBILI / AVAILABLE FINISHING:	DESCRIZIONE: DESCRIPTION:
ORL oro lucido glossy gold	MINUTERIA PARTS
CUS rame satinato satin copper	

FC0902

h 15 mm - Ø20 mm

MATERIALE: ZAMA / MATERIAL: ZAMAK	
FINITURE DISPONIBILI / AVAILABLE FINISHING:	DESCRIZIONE: DESCRIPTION:
OTS ottone satinato satin brass	MINUTERIA PARTS
ORL oro lucido glossy gold	
CUS rame satinato satin copper	
NLL nikel lucido glossy nickel	



Gemma con fissaggio calamitato

FC0903

h 15 mm - Ø20 mm

MATERIALE: ZAMA / MATERIAL: ZAMAK	
FINITURE DISPONIBILI / AVAILABLE FINISHING:	DESCRIZIONE: DESCRIPTION:
ORL oro lucido glossy gold	DECORAZIONE DECORATION
FC0903ORL/BI: bianco / white	
FC0903ORL/RO: rosa / pink	
FC0903ORL/BL: blu / blue	

FC0904INS

FC0904

h 18 mm - Ø16 mm

MATERIALE: ZAMA / MATERIAL: ZAMAK	
FINITURE DISPONIBILI / AVAILABLE FINISHING:	DESCRIZIONE: DESCRIPTION:
ORL oro lucido glossy gold	DECORAZIONE DECORATION
FC0904ORL/BI: bianco / white	
FC0904ORL/RO: rosa / pink	
FC0904ORL/BL: blu / blue	
FC0904INS: inserto per FC0904 / FC0904 insert	

FC0502

140x90 mm

<i>MATERIALE: ZAMA / MATERIAL: ZAMAK</i>	
<i>FINITURE DISPONIBILI /AVAILABLE FINISHING:</i>	<i>DESCRIZIONE: DESCRIPTION:</i>
OTS <small>ottone satinato satin brass</small>	<i>CORNICE FRAME</i>
ORL <small>oro lucido glossy gold</small>	
CUS <small>rame satinato satin copper</small>	

FC0504

180x120 mm

<i>MATERIALE: ZAMA / MATERIAL: ZAMAK</i>	
<i>FINITURE DISPONIBILI /AVAILABLE FINISHING:</i>	<i>DESCRIZIONE: DESCRIPTION:</i>
OTS <small>ottone satinato satin brass</small>	<i>CORNICE FRAME</i>
ORL <small>oro lucido glossy gold</small>	

FC1759

300 mm

FC1760

420 mm

<i>MATERIALE: METALLO / MATERIAL: METAL</i>	
<i>FINITURE DISPONIBILI / AVAILABLE FINISHING:</i>	<i>FISSAGGIO: / FIXING:</i>
ORL oro lucido glossy gold	 Ø2

<i>MATERIALE: METALLO / MATERIAL: METAL</i>	
<i>FINITURE DISPONIBILI / AVAILABLE FINISHING:</i>	<i>FISSAGGIO: / FIXING:</i>
ORL oro lucido glossy gold	 Ø2

FC1762

600 mm

<i>MATERIALE: METALLO / MATERIAL: METAL</i>	
<i>FINITURE DISPONIBILI / AVAILABLE FINISHING:</i>	<i>FISSAGGIO: / FIXING:</i>
ORL oro lucido glossy gold	 Ø2

FC1763

300 mm

<i>MATERIALE: METALLO / MATERIAL: METAL</i>	
<i>FINITURE DISPONIBILI / AVAILABLE FINISHING:</i>	<i>FISSAGGIO: / FIXING:</i>
ORL oro lucido glossy gold	 Ø2



FC0910

480 X 120 mm

FC0911

355 x 104 mm

MATERIALE: ZAMA / MATERIAL: ZAMAK	
FINITURE DISPONIBILI / AVAILABLE FINISHING: OTS ottone satinato satin brass	FISSAGGIO: / FIXING:  Ø2

MATERIALE: ZAMA / MATERIAL: ZAMAK	
FINITURE DISPONIBILI / AVAILABLE FINISHING: ORL oro lucido glossy gold OTS ottone satinato satin brass NLL nikel lucido glossy nikel	FISSAGGIO: / FIXING:  Ø2

FC4301

480 X 120 mm

FC2602

330 mm

MATERIALE: PLASTICA / MATERIAL: PLASTIC	
FINITURE DISPONIBILI / AVAILABLE FINISHING:	
ORL	oro lucido glossy gold
FISSAGGIO: / FIXING:	
Ø2	

MATERIALE: OTTONE / MATERIAL: BRASS	
FINITURE DISPONIBILI / AVAILABLE FINISHING:	
FML	finitura lucida glossy finishing
FMS	finitura satinata satin finishing
FISSAGGIO: / FIXING:	
Ø2	

FC1777

FC1779

FC1781

FC1780
300mm

FC1784

FC1785

MATERIALE: METALLO / MATERIAL: METAL

FINITURE DISPONIBILI / AVAILABLE FINISHING:

FISSAGGIO:
FIXING:

AGL argento lucido
glossy silver

Rose con gambo color argento



Ø2

FC1778
FC1782
 300mm

FC1783

MATERIALE: METALLO / MATERIAL: METAL

FINITURE DISPONIBILI / AVAILABLE FINISHING:

ORL oro lucido
 glossy gold

Rose con gambo color oro

 FISSAGGIO:
 FIXING:

Ø2

**SC/R**

solo per rose da 300mm - NON adatta a rose XL

MATERIALE: CARTONE / MATERIAL: CARDBOARD

SCATOLA PORTA ROSA / ROSE BOX

FC1786

FC1789

FC1788

FC1792
FC1787

330mm

MATERIALE: METALLO / MATERIAL: METAL

FINITURE DISPONIBILI / AVAILABLE FINISHING:

 FISSAGGIO:
FIXING:

AGL argento lucido
glossy silver

Rose MAXI con gambo color argento

Ø2

FC1795
FC1796

330mm

MATERIALE: METALLO / MATERIAL: METAL

FINITURE DISPONIBILI / AVAILABLE FINISHING:

 FISSAGGIO:
FIXING:

ORL oro lucido
glossy gold

Rose MAXI con gambo color oro

Ø2



SC/RM

solo per rose XL da 330mm

MATERIALE: CARTONE / MATERIAL: CARDBOARD

SCATOLA PORTA ROSA / ROSE BOX

TARGHE

PLATES

ZORSOL





TA01ORL/NER/P

125x80 mm

MATERIALE: ALLUMINIO/MATERIAL: ALUMINIUM	
FINITURE DISPONIBILI /AVAILABLE FINISHING: /P:piana/flat - /B:bombata/rounded - /E:sp.0,5mm NER ORL /P CUL NER /P NER ORL /P/E ORL NER /P/E	FISSAGGIO: FIXING: 



TA02ORS/ORL/P

125x80 mm

MATERIALE: ALLUMINIO/MATERIAL: ALUMINIUM	
FINITURE DISPONIBILI /AVAILABLE FINISHING: /P:piana/flat - /B:bombata/rounded - /E:sp.0,5mm ORS ORL /P ORS ORL /P/A	FISSAGGIO: FIXING:  AUTOADESIVO SELF-ADHESIVE /A

TA03CUS/CUL/P

145x85 mm

MATERIALE: ALLUMINIO/MATERIAL: ALUMINIUM	
FINITURE DISPONIBILI /AVAILABLE FINISHING: /P:piana/flat - /B:bombata/rounded - /E:sp.0,5mm ORS ORL /P NLS NLL /P ORS ORL /P/A NLS NLL /P/A CUS CUL /P/A	FISSAGGIO: FIXING:  AUTOADESIVO SELF-ADHESIVE /A



TA04ORS/ORL/P/A

40x70 mm

MATERIALE: ALLUMINIO/MATERIAL: ALUMINIUM	
FINITURE DISPONIBILI /AVAILABLE FINISHING: /P:piana/flat - /B:bombata/rounded - /E:sp.0,5mm NER ORL /P/A piana adesiva / adhesive flat	FISSAGGIO: FIXING: AUTOADESIVO SELF-ADHESIVE /A



TA05ORS/ORL/P

100x50 mm

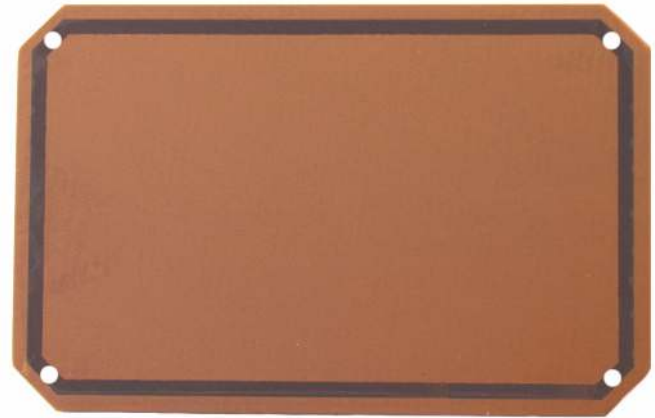
MATERIALE: ALLUMINIO/MATERIAL: ALUMINIUM	
FINITURE DISPONIBILI /AVAILABLE FINISHING: /P:piana/flat - /B:bombata/rounded - /E:sp.0,5mm NLL /P /A	FISSAGGIO: FIXING:  AUTOADESIVO SELF-ADHESIVE /A



TA06CUS/CUL/P

140x90 mm

MATERIALE: ALLUMINIO/MATERIAL: ALUMINIUM	
FINITURE DISPONIBILI /AVAILABLE FINISHING: /P:piana/flat - /B:bombata/rounded - /E:sp.0,5mm ORS ORL /P ORS ORL /P/A CUS CUL /P/A	FISSAGGIO: FIXING:  AUTOADESIVO SELF-ADHESIVE /A



TA07CUL/NER/B

154x91 mm

MATERIALE: ALLUMINIO/MATERIAL: ALUMINIUM	
FINITURE DISPONIBILI /AVAILABLE FINISHING: /P:piana/flat - /B:bombata/rounded - /E:sp.0,5mm NER ORL /B /P ORL NER /B /P NER ORL /B/E /P/E ORL /B ORL NER /B/E /P/E	FISSAGGIO: FIXING: 



TA08NER/ORL/B

145x85 mm

MATERIALE: ALLUMINIO/MATERIAL: ALUMINIUM	
FINITURE DISPONIBILI /AVAILABLE FINISHING: /P:piana/flat - /B:bombata/rounded - /E:sp.0,5mm NER ORL /P ORL /B ORL /P NER ORL /P/E	FISSAGGIO: FIXING: 



TA09CUL/NER/B

150x90 mm

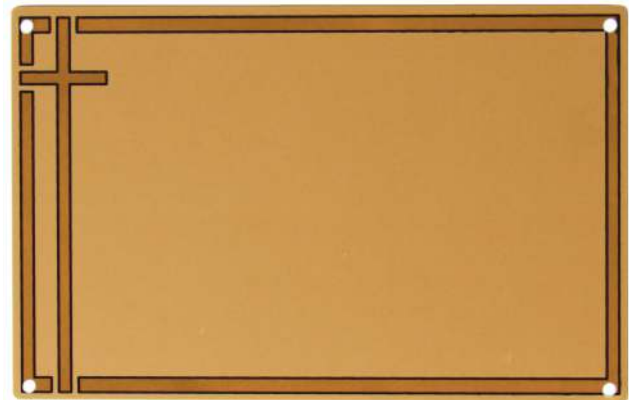
<i>MATERIALE: ALLUMINIO / MATERIAL: ALUMINIUM</i>	
<i>FINITURE DISPONIBILI / AVAILABLE FINISHING:</i> <i>/P:piana/flat - /B:bombata/rounded - /E:sp.0,5mm</i>	<i>FISSAGGIO:</i> <i>FIXING:</i>
ORL NER /B	



TA10ORS/ORL/P

125x80 mm

<i>MATERIALE: ALLUMINIO / MATERIAL: ALUMINIUM</i>	
<i>FINITURE DISPONIBILI / AVAILABLE FINISHING:</i> <i>/P:piana/flat - /B:bombata/rounded - /E:sp.0,5mm</i>	<i>FISSAGGIO:</i> <i>FIXING:</i>
CUS CUL /P	

TA11ORL/NER/B

145x117 mm

<i>MATERIALE: ALLUMINIO / MATERIAL: ALUMINIUM</i>	
<i>FINITURE DISPONIBILI / AVAILABLE FINISHING:</i> <i>/P:piana/flat - /B:bombata/rounded - /E:sp.0,5mm</i>	<i>FISSAGGIO:</i> <i>FIXING:</i>
	

/M

/G

/P
TA11

<i>MATERIALE: ADESIVO / MATERIAL: ADHESIVE</i>	
<i>FINITURE DISPONIBILI / AVAILABLE FINISHING:</i> <i>/P:piana/flat - /B:bombata/rounded - /E:sp.0,5mm</i>	<i>FISSAGGIO:</i> <i>FIXING:</i>
	AUTOADESIVO SELF-ADHESIVE



TA12NER/ORL/P

110x160 mm

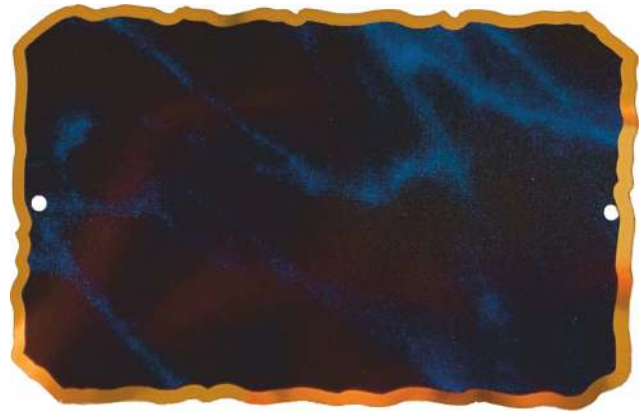
MATERIALE: ALLUMINIO/MATERIAL: ALUMINIUM																			
FINITURE DISPONIBILI /AVAILABLE FINISHING: /P:piana/flat - /B:bombata/rounded - /E:sp.0,5mm	FISSAGGIO: FIXING:																		
<table border="0"> <tr> <td>NER</td> <td>ORL</td> <td>/B</td> </tr> <tr> <td></td> <td></td> <td>/P</td> </tr> <tr> <td>NER</td> <td>ORL</td> <td>/B/E</td> </tr> <tr> <td></td> <td></td> <td>/P/E</td> </tr> <tr> <td>ORL</td> <td>NER</td> <td>/B/E</td> </tr> <tr> <td></td> <td></td> <td>/P/E</td> </tr> </table>	NER	ORL	/B			/P	NER	ORL	/B/E			/P/E	ORL	NER	/B/E			/P/E	
NER	ORL	/B																	
		/P																	
NER	ORL	/B/E																	
		/P/E																	
ORL	NER	/B/E																	
		/P/E																	



TA13BLU/ORL/P

140x90 mm

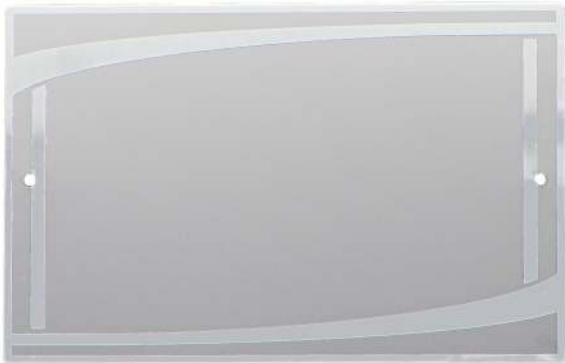
MATERIALE: ALLUMINIO/MATERIAL: ALUMINIUM							
FINITURE DISPONIBILI /AVAILABLE FINISHING: /P:piana/flat - /B:bombata/rounded - /E:sp.0,5mm	FISSAGGIO: FIXING:						
<table border="0"> <tr> <td>RAD</td> <td>ORL</td> <td>/P</td> </tr> <tr> <td>VER</td> <td>ORL</td> <td>/P</td> </tr> </table>	RAD	ORL	/P	VER	ORL	/P	
RAD	ORL	/P					
VER	ORL	/P					

TA15NLS/NLL/P

125x80 mm

MATERIALE: ALLUMINIO/MATERIAL: ALUMINIUM				
FINITURE DISPONIBILI /AVAILABLE FINISHING: /P:piana/flat - /B:bombata/rounded - /E:sp.0,5mm	FISSAGGIO: FIXING:			
<table border="0"> <tr> <td>ORS</td> <td>ORL</td> <td>/P</td> </tr> </table>	ORS	ORL	/P	
ORS	ORL	/P		

TA16ORL/P/A

125x80 mm

MATERIALE: ALLUMINIO/MATERIAL: ALUMINIUM			
FINITURE DISPONIBILI /AVAILABLE FINISHING: /P:piana/flat - /B:bombata/rounded - /E:sp.0,5mm	FISSAGGIO: FIXING:		
<table border="0"> <tr> <td>CUS</td> <td>/P/A</td> </tr> </table>	CUS	/P/A	AUTOADESIVO SELF-ADHESIVE /A
CUS	/P/A		

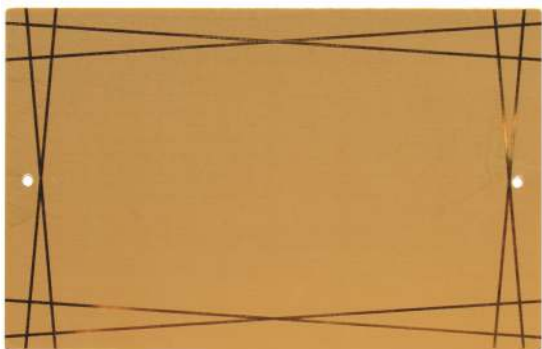
TA17ORS/ORL/P

125x80 mm

MATERIALE: ALLUMINIO / MATERIAL: ALUMINIUM	
FINITURE DISPONIBILI /AVAILABLE FINISHING: /P:piana/flat - /B:bombata/rounded - /E:sp.0,5mm	FISSAGGIO: FIXING:

TA2000FML/P

140x100 mm

MATERIALE: OTTONE / MATERIAL: BRASS	
FINITURE DISPONIBILI /AVAILABLE FINISHING: /P:piana/flat - /B:bombata/rounded - /E:sp.0,5mm	FISSAGGIO: FIXING:

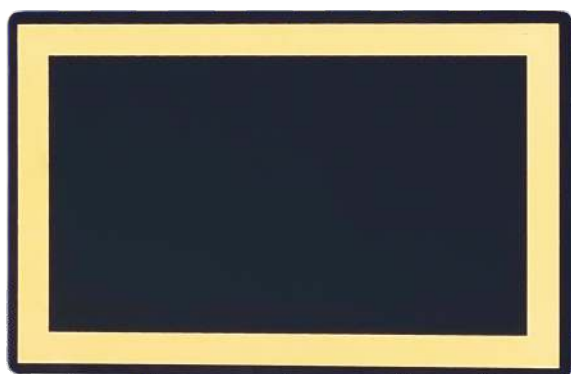
TA20NER/ORL/P/A

125x80 mm

MATERIALE: ALLUMINIO / MATERIAL: ALUMINIUM	
FINITURE DISPONIBILI /AVAILABLE FINISHING: /P:piana/flat - /B:bombata/rounded - /E:sp.0,5mm ORS ORL /P/A	FISSAGGIO: FIXING: AUTOADESIVO SELF-ADHESIVE /A

TA23NER/ORL/P/A

88x60 mm

MATERIALE: ALLUMINIO / MATERIAL: ALUMINIUM	
FINITURE DISPONIBILI /AVAILABLE FINISHING: /P:piana/flat - /B:bombata/rounded - /E:sp.0,5mm NER NLL /P/A ORL /P	FISSAGGIO: FIXING: AUTOADESIVO SELF-ADHESIVE /A

TA4001NER/ORL/NLL/P/A
125x80 mm

<i>MATERIALE: PLASTICA / MATERIAL: PLASTIC</i>	
<i>FINITURE DISPONIBILI /AVAILABLE FINISHING: /P:piana/flat - /B:bombata/rounded - /E:sp.0,5mm</i>	<i>FISSAGGIO: FIXING:</i>
	<i>AUTOADESIVO SELF-ADHESIVE /A</i>

TA4002/ORL/P
130x80x1,5 mm

<i>MATERIALE: PLASTICA / MATERIAL: PLASTIC</i>	
<i>FINITURE DISPONIBILI /AVAILABLE FINISHING: /P:piana/flat - /B:bombata/rounded - /E:sp.0,5mm</i>	<i>FISSAGGIO: FIXING:</i>
	

URNE

URNS

ZORSOL





UR058



UR007



UR142



UR056



UR059



UR099



UR100



UR125



UR008



UR009



UR010



UR140



UR141

4 lt. - h235 mm - Ø160 mm

5 lt. - h253 mm - Ø184 mm

MATERIALE: METALLO / MATERIAL: METAL

MATERIALE: METALLO / MATERIAL: METAL



UR012

5 lt. - h270 mm - Ø185 mm

MATERIALE: METALLO / MATERIAL: METAL



UR013

5 lt. - h260 mm - Ø184 mm

MATERIALE: METALLO / MATERIAL: METAL



UR015

5 lt. - h253 mm - Ø184 mm

MATERIALE: METALLO / MATERIAL: METAL



UR016

5 lt. - h253 mm - Ø184 mm

MATERIALE: METALLO / MATERIAL: METAL



UR017

3 lt. - h270 mm - Ø185 mm

MATERIALE: METALLO / MATERIAL: METAL



UR018

5 lt. - h270 mm - Ø185 mm

MATERIALE: METALLO / MATERIAL: METAL



UR019

5 lt. - h270 mm - Ø185 mm

MATERIALE: METALLO / MATERIAL: METAL



UR020

5 lt. - h253 mm - Ø184 mm

MATERIALE: METALLO / MATERIAL: METAL



UR021

5 lt. - h280 mm - Ø184 mm

MATERIALE: METALLO / MATERIAL: METAL



UR022

5 lt. - h280 mm - Ø184 mm

MATERIALE: METALLO / MATERIAL: METAL

**UR023**

5 lt. - h270 mm - Ø185 mm

MATERIALE: METALLO / MATERIAL: METAL

**UR024**

5 lt. - h253 mm - Ø184 mm

MATERIALE: METALLO / MATERIAL: METAL

**UR026**

5 lt. - h253 mm - Ø184 mm

MATERIALE: METALLO / MATERIAL: METAL

**UR035**

5 lt. - h260 mm - Ø184 mm

MATERIALE: METALLO / MATERIAL: METAL



UR103



UR115

UR103 - UR115

4 lt. - h245 mm - Ø190 mm

MATERIALE: VETRORESINA / MATERIAL: FIBERGLASS



UR105



UR106

UR105 - UR106

4 lt. - h255 mm - 255x195 mm

MATERIALE: VETRORESINA / MATERIAL: FIBERGLASS



UR116

4.1 lt. - h240 mm - 265x145 mm

MATERIALE: VETRORESINA / MATERIAL: FIBERGLASS



UR117

3 lt. - h270 mm - Ø185 mm

MATERIALE: VETRORESINA / MATERIAL: FIBERGLASS



UR121

3.8 lt. - h205 mm - Ø200 mm

MATERIALE: VETRORESINA / MATERIAL: FIBERGLASS



UR107



UR108

UR107 - UR108

4 lt. - h250 mm - Ø200 mm

MATERIALE: VETRORESINA / MATERIAL: FIBERGLASS

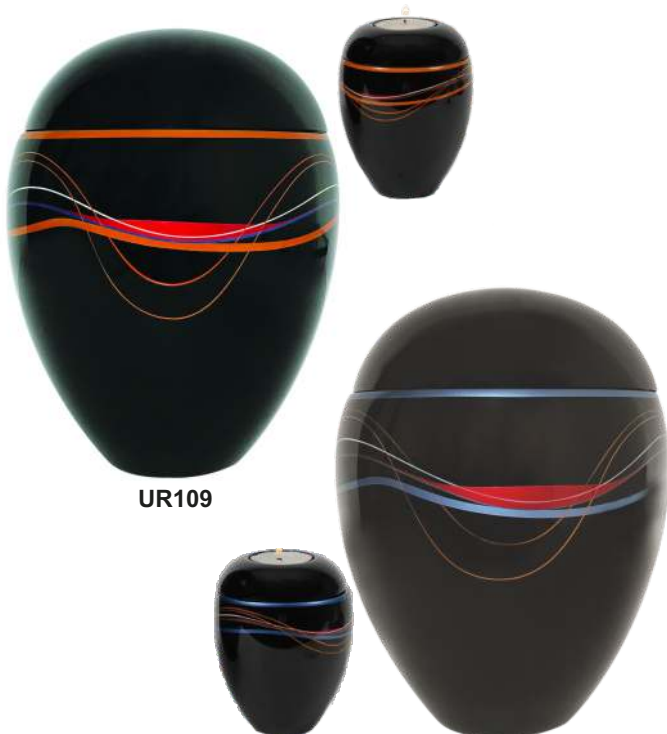

UR109

UR110

UR109 - UR110

3.2 lt. - h250 mm - Ø190 mm

MATERIALE: VETRORESINA / MATERIAL: FIBERGLASS



UR111



UR112

UR111 - UR112

3.5 lt. - h230 mm - 265x135 mm

MATERIALE: VETRORESINA / MATERIAL: FIBERGLASS



UR524

5 lt. - 585 x 435 x 50 mm

MATERIALE: MDF / MATERIAL: MDF

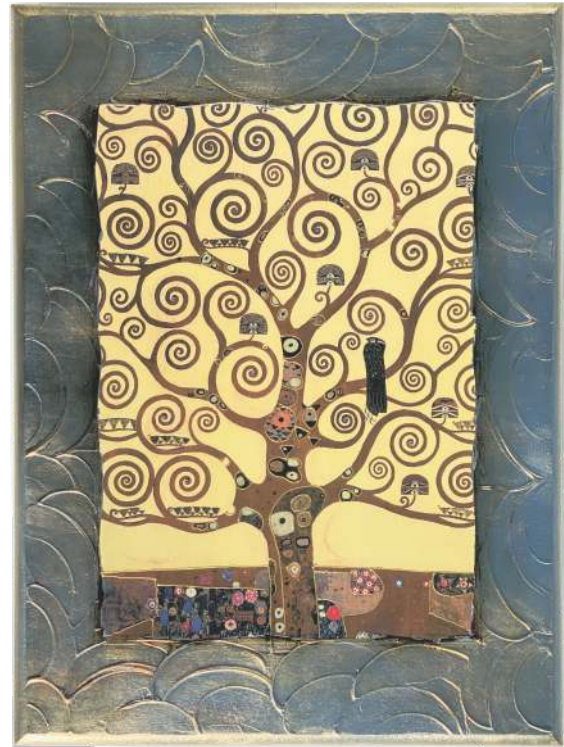

UR526

5 lt. - 585 x 435 x 50 mm

MATERIALE: MDF / MATERIAL: MDF



UR525

5 lt. - 585 x 435 x 50 mm

MATERIALE: MDF / MATERIAL: MDF



UR527

5 lt. - 585 x 435 x 50 mm

MATERIALE: MDF / MATERIAL: MDF



UR510

4.5 lt. - h270 mm - 260X190 mm

MATERIALE: LEGNO / MATERIAL: WOOD



UR511

4.5 lt. - h270 mm - 260x190 mm

MATERIALE: LEGNO / MATERIAL: WOOD



UR512

4.9 lt. - h190 mm - 280x190 mm

MATERIALE: LEGNO / MATERIAL: WOOD



UR513



UR514

UR513 - UR514

5.1 lt. - h60 mm - 520x390 mm

MATERIALE: LEGNO / MATERIAL: WOOD



UR520

4.5 lt. - 200 x 200 x 210 mm

MATERIALE: LEGNO / MATERIAL: WOOD



UR522

4.5 lt. - 200 x 200 x 200 mm

MATERIALE: LEGNO / MATERIAL: WOOD



UR530/RO



UR531/RO



UR530/RS



UR531/RS

UR530/RO - UR530/RS

3.77 lt. - 290 x 180 x 100 mm

MATERIALE: MDF / MATERIAL: MDF

UR531/RO - UR531/RS

5.12 lt. - 290 x 180 x 130 mm

MATERIALE: MDF / MATERIAL: MDF



UR122

4.7 lt. - h255m - 170x170 mm

MATERIALE: MDF / MATERIAL: MDF



UR410

3 lt. - 210 x 210 x 100 mm

MATERIALE: PLEXIGLASS / MATERIAL: PLEXIGLASS



UR411

3 lt. - 210 x 210 x 100 mm

MATERIALE: PLEXIGLASS / MATERIAL: PLEXIGLASS



UR412

3 lt. - 210 x 210 x 100 mm

MATERIALE: PLEXIGLASS / MATERIAL: PLEXIGLASS





Ultra Slim
 →)(←
 soltanto 8cm

UR400

5 lt. - 330 x 255 x 80 mm

MATERIALE: PLEXIGLASS / MATERIAL: PLEXIGLASS



Ultra Slim
 →)(←
 soltanto 8cm

UR401

5 lt. - 330 x 255 x 80 mm

MATERIALE: PLEXIGLASS / MATERIAL: PLEXIGLASS



Ultra Slim
 →)(←
 soltanto 8cm

UR402

5 lt. - 330 x 255 x 80 mm

MATERIALE: PLEXIGLASS / MATERIAL: PLEXIGLASS



UR101

3.5 lt. - 275 x 230 x 150 mm

MATERIALE: CERAMICA / MATERIAL: CERAMIC

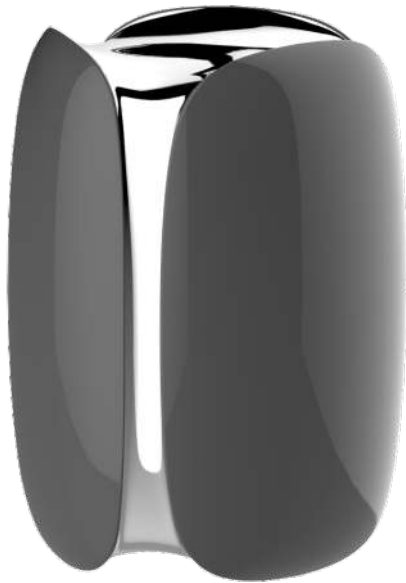

UR300



UR312



UR304 UR305 UR302 UR301 UR303 UR306

4.5 lt. - 250 x 185 x 185 mm

MATERIALE: CERAMICA / MATERIAL: CERAMIC



UR311 UR314 UR315 UR316 UR313 UR329

4.7 lt. - 250 x 185 x 185 mm

MATERIALE: CERAMICA / MATERIAL: CERAMIC



UR317



UR331



UR318 UR319 UR320 UR321 UR322 UR330

5 lt. - 250 x 200 x 200 mm

MATERIALE: CERAMICA / MATERIAL: CERAMIC



UR323 UR324 UR325 UR326 UR327 UR328

5 lt. - 250 x 190 x 190 mm

MATERIALE: CERAMICA / MATERIAL: CERAMIC



UR127

UR130

UR128

UR127 - UR128 - UR130

4 lt. - h235 mm - Ø175 mm

BIODEGRADABILE



UR049

UR050

UR049 - UR050

5 lt. - h270 mm - Ø185 mm

BIODEGRADABILE



mod. A

mod. B

mod. C

mod. D

UR123

4 lt. - h330 mm - Ø130 mm

BIODEGRADABILE

per dispersione



mod. A

mod. B

UR123/S

3,5 lt. - h290 mm - Ø140 mm

BIODEGRADABILE

per dispersione

ACCESSORI PER URNE

URNS ACCESSORIES

ZORSOL





UR998

sacchetto/bag - 170x111x570 mm



UR990

sacchetto/bag - 300x400 mm



UR992

Ø7 mm



UR993

60X25 mm

PRODOTTI TECNICI

TECHNICAL PRODUCTS

ZORSOL



PT0810 - PT0811

BIODEGRADABILE / BIODEGRADABLE

DESCRIZIONE / DESCRIPTION:

**MENTONIERA
CHIN**

*PT0810: taglia / size M
PT0811: taglia / size L*

PT0813

l. 56 mm

DESCRIZIONE / DESCRIPTION:

**MENTONIERA A VITE
SCREW CHIN**

PT0814

l. 70 - 115 mm

DESCRIZIONE / DESCRIPTION:

**MENTONIERA A SCATTO
FIT CHIN**

PT0884

DESCRIZIONE / DESCRIPTION:

**FERMA SCARPE
STOPS SHOES**

ZOR03301

100 pz.

PVC / PVC

DESCRIZIONE / DESCRIPTION:

*COPRI OCCHI
EYE COVER*

ZOR03303

100 pz.

PVC / PVC

DESCRIZIONE / DESCRIPTION:

*COPRI OCCHI
EYE COVER*

ZOR03309

12 pz.

DESCRIZIONE / DESCRIPTION:

*FERMA BOCCA
MOUTH HOLD*

per soggetti privi di dentatura

ZOR03311

12 pz.

VINILE / VINYL

DESCRIZIONE / DESCRIPTION:

*FERMA BOCCA
MOUTH HOLD*

PT0885

<p><i>DESCRIZIONE / DESCRIPTION:</i></p> <p>FERMA MANI HANDS STOP</p>

PT0829

3 gr

<p><i>DESCRIZIONE / DESCRIPTION:</i></p> <p>BUSTINE SUPER ASSORBENTI ABSORBENT BAGS</p>

PT0830

1 Kg

PT0831

8 Kg

<p><i>DESCRIZIONE / DESCRIPTION:</i></p> <p>ABSOL - POLVERE ASSORBENTE ABSOL - ABSORBENT DUST</p>



PT0891

900 gr

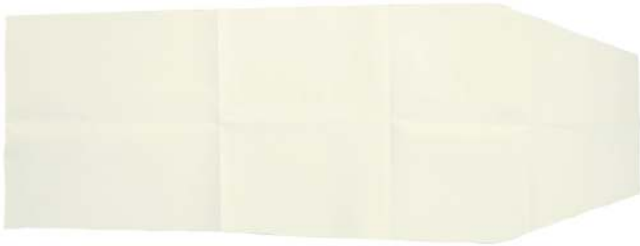
<p><i>DESCRIZIONE / DESCRIPTION:</i></p> <p>DEGREZIMATIC - POLVERE SCHELETRIZZANTE DEGREZIMATIC - SKELETON FORMING POWDER</p>

PT0852
210x60 cm - 70 litri
PT0894
210x70 cm - 60 litri
BIODEGRADABILE / BIODEGRADABLE
DESCRIZIONE / DESCRIPTION:

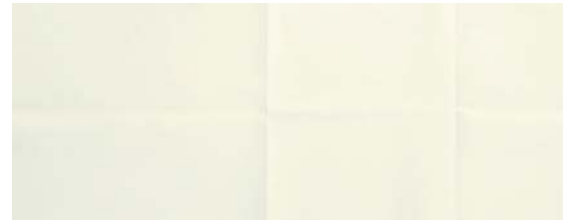
*MATERASSINO ASSORBENTE
ABSORBENT BEDDING*

PT0870
210x77 cm - 20 litri
PT0893
210x67 cm - 60 litri
BIODEGRADABILE / BIODEGRADABLE
DESCRIZIONE / DESCRIPTION:

*MATERASSINO ASSORBENTE
ABSORBENT BEDDING*

PT0870: ovatta viscosa accoppiata con carta

PT0848
180x240 cm - 40 micron
PT0848/B
130x210 cm - 40 micron
MATERIALE: MATER-B / MATERIAL: MATER-B
DESCRIZIONE / DESCRIPTION:

COLTRINETTO

PT0849
130 x 210 cm
MATERIALE: PVC / MATERIAL: PVC
DESCRIZIONE / DESCRIPTION:

COLTRINETTO

PT0854
260 x 160 cm
MATERIALE: POLIETILENE / MATERIAL: POLYETHYLENE
DESCRIZIONE / DESCRIPTION:
COLTRINETTO

PT0866
250x105 cm - 60 micron
BIODEGRADABILE / BIODEGRADABLE
DESCRIZIONE / DESCRIPTION:
**SACCO ERMETICO PER CREMAZIONE
CON CERNIERA
ERMETIC BAG FOR CREMATION
WITH ZIP**

PT0892
255x92 cm - 44 micron
BIODEGRADABILE / BIODEGRADABLE
DESCRIZIONE / DESCRIPTION:
**SACCO ERMETICO PER CREMAZIONE
CON CERNIERA
ERMETIC BAG FOR CREMATION
WITH ZIP**

PT0898
248x88 cm - 44 micron
BIODEGRADABILE / BIODEGRADABLE
DESCRIZIONE / DESCRIPTION:
**SACCO ERMETICO PER CREMAZIONE
CON BIADDESIVO
ERMETIC BAG FOR CREMATION
WITH SELFADHESIVE**

PT0855L - PT0909Z

220 x 100 cm

MATERIALE: PVC / MATERIAL: PVC

DESCRIZIONE / DESCRIPTION:

SACCO RECUPERO SALME
SALME RECOVERY BAG

PT0855L - portata/weight capacity: 200Kg
PT0909Z - portata/weight capacity: oltre/over 170Kg

PT0966

125 X 245 cm

DESCRIZIONE / DESCRIPTION:

SACCO RIFIUTI CIMITERIALI
CIMITERIAL WASTE BAG

PT0818

220 x 80 cm - portata 180Kg

MATERIALE: POLIPROPILENE / MATERIAL: POLIPROPILENE

DESCRIZIONE / DESCRIPTION:

SACCO RECUPERO SALME
SALME RECOVERY BAG

PT0819

225 x 88 cm - portata 80Kg

MATERIALE: TNT / MATERIAL: TNT

DESCRIZIONE / DESCRIPTION:

SACCO RECUPERO SALME
SALME RECOVERY BAG

*il colore può differire dalla foto in base alla disponibilità del materiale.

PT0977

30x60x36 cm

MATERIALE: CARTONE / MATERIAL: CARDBOARD

DESCRIZIONE / DESCRIPTION:

SCATOLA MONOUSO PER RESTI
DISPOSABLE BOX FOR BIOLOGICAL WASTE

PT0937

5 pz.

MATERIALE: CARTONE / MATERIAL: CARDBOARD

DESCRIZIONE / DESCRIPTION:

CASSA RECUPERO SALME
SALME RECOVERY BOX

PT0817

235 x 80 cm

MATERIALE: TESSUTO / MATERIAL: FABRIC

DESCRIZIONE / DESCRIPTION:

SACCO AEREO CON CERNIERA
AIRPLANE BAG WITH ZIP

PTR100

2240 mm x 640 mm x h.510mm

MATERIALE: PE/AI/ACCIAIO / MATERIAL: PE/AI/STEEL

DESCRIZIONE / DESCRIPTION:

CASSONE DA RECUPERO
RECOVERY CHEST

PT1018

peso/weight: 13,5 Kg - portata/weight capacity: 300Kg

MATERIALE: ALLUMINIO / MATERIAL: ALUMINIUM

DESCRIZIONE / DESCRIPTION:

CARRELLO FUNERARIO ESTENSIBILE
EXTENDABLE FUNERARY TROLLEY

PT1019

peso/weight: 11 Kg - portata/weight capacity: 300Kg

MATERIALE: ACCIAIO / MATERIAL: STEEL

DESCRIZIONE / DESCRIPTION:

CARRELLO FUNERARIO ESTENSIBILE CON MANICI
EXTENDABLE FUNERARY TROLLEY WITH HANDLES

PT1034

peso/weight: 14,5 Kg - portata/weight capacity: 300Kg

MATERIALE: ACCIAIO / MATERIAL: STEEL

DESCRIZIONE / DESCRIPTION:

CARRELLO FUNERARIO ESTENSIBILE CON MANICI
EXTENDABLE FUNERARY TROLLEY WITH HANDLES

PT1035

peso/weight: 26,5 Kg - portata/weight capacity: 270Kg

MATERIALE: ACCIAIO / MATERIAL: STEEL

DESCRIZIONE / DESCRIPTION:

CARRELLO ELEVATORE OLEODINAMICO
HYDRAULIC FUNERARY TROLLEY

PT0867
10 pz.
MATERIALE: TNT / MATERIAL: TNT
DESCRIZIONE / DESCRIPTION:

*CAMICE CON POLSINI
OVERALL*

PT0901
SMS <180 g
MATERIALE: SMS / MATERIAL: SMS
DESCRIZIONE / DESCRIPTION:

*TUTA DI PROTEZIONE MONOUSO
DISPOSABLE PROTECTIVE SUIT*

PT0902
tyvec 60 g/m²
MATERIALE: YVEC / MATERIAL: TYVEC
DESCRIZIONE / DESCRIPTION:

*TUTA DI PROTEZIONE MONOUSO
DISPOSABLE PROTECTIVE SUIT*

PT0914
100 pz
MATERIALE: CPE / MATERIAL: CPE
DESCRIZIONE / DESCRIPTION:

*SOVRASCARPE MONOUSO
SINGLE USE OVERSHOSE*

PT0913
DESCRIZIONE / DESCRIPTION:

OCCHIALI IN POLICARBONATO MONOBLOCCO
MONOBLOCK POLYCARBONATE GLASSES

PT0915
DESCRIZIONE / DESCRIPTION:

OCCHIALE A MASCHERINA - FORI DI AREAZIONE
MASKED GLASSES WITH AERATION HOLES

PT0931

500 ml

DESCRIZIONE / DESCRIPTION:

GEL ANTIBATTERICO
ANTIBACTERIAL GEL

PT0861

MATERIALE: NITRILE / MATERIAL: NITRILE

DESCRIZIONE / DESCRIPTION:

GUANTI
GLOVES

PT0827

PT0872

DESCRIZIONE / DESCRIPTION:

MASCHERINA FFP2
FFP2 MASK

DESCRIZIONE / DESCRIPTION:

MASCHERINA FFP3 CON VALVOLA
FFP3 MASK WITH VALVE

PT0900

100 pz

MATERIALE: CARTA / MATERIAL: PAPER

DESCRIZIONE / DESCRIPTION:

CARTONCINI PROFUMATI
SCENTED CARDS

agrumi / citrus fruits

PT0908

50 pz

MATERIALE: CARTA / MATERIAL: PAPER

DESCRIZIONE / DESCRIPTION:

CARTONCINI PROFUMATI
SCENTED CARDS

eucalipto / eucalyptus



PT0926
1 Kg



PT0932
10 Kg



PT0927
750 ml

DESCRIZIONE / DESCRIPTION:

DISINFETTANTE DETERGENTE SGRASSANTE
DISINFECTANT DETERGENT DEGREASER

DESCRIZIONE / DESCRIPTION:

DISINFETTANTE DETERGENTE PRONTO ALL'USO
READY TO USE
DISINFECTANT DETERGENT DEGREASER



PT0929

DESCRIZIONE / DESCRIPTION:

LENZUOLO PRE-IMBEVUTO OMOLOGATO
APPROVED SOAKED BED SHEET



PT0887

DESCRIZIONE / DESCRIPTION:

KIT DISINFETTANTE INFETTIVI OMOLOGATO
APPROVED INFECTIVE DISINFECTANT KIT

PT0888

250 ml

BIODEGRADABILE / BIODEGRADABLE

DESCRIZIONE / DESCRIPTION:

 GREEN SPRAY TRIPLA AZIONE
 TRIPLE ACTION GREEN SPRAY

PT0841

DESCRIZIONE / DESCRIPTION:

BOMBOLETTA SANIFICANTE ONESHOT

ONESHOT SANITIZING BOTTLE

PT0874

400 ml

DESCRIZIONE / DESCRIPTION:

 SPRAY MEDICAL
 SPRAY MEDICAL

PT0875

400 ml

DESCRIZIONE / DESCRIPTION:

 DETERGENTE SCHIUMOSO PER SALME
 SALME FOAMING CLEANER

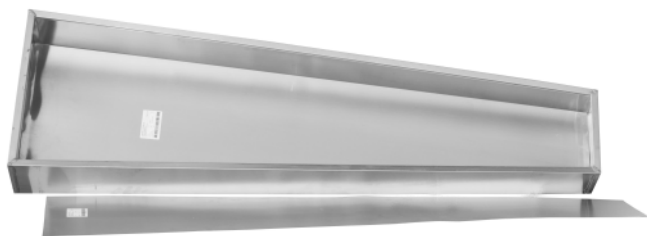
PT094#

180 x 55 cm

MATERIALE: ZINCO / MATERIAL: ZINC

DESCRIZIONE / DESCRIPTION:

SOGLIOLA IN ZINCO
ZINC SOLE

PT0944: H 14 CM
PT0946: H 16 CM
PT0958: H 18 CM
PT0947: H 20 CM

PT0948

210 x 70 x 43 cm

MATERIALE: ZINCO / MATERIAL: ZINC

DESCRIZIONE / DESCRIPTION:

CASSONE RETTANGOLARE
RECTANGULAR BOX



PT0949

210 x 70 x 43 cm

MATERIALE: ZINCO / MATERIAL: ZINC

DESCRIZIONE / DESCRIPTION:

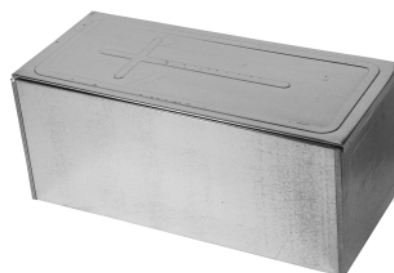
CASSONE SPALLATO
SHOULDERED BOX

PT0950

55 x 24 x 23 cm

MATERIALE: LAMIERA ZINCATA / GALVANIZED SHEET METAL

DESCRIZIONE / DESCRIPTION:

OSSARIO
OSSUARY

PT0951

60 x 27 x 27 cm

MATERIALE: LAMIERA ZINCATA / GALVANIZED SHEET METAL

DESCRIZIONE / DESCRIPTION:

OSSARIO DOPPIO
DOUBLE OSSUARY

PT0952

56 x 22 x 36 cm

MATERIALE: LAMIERA ZINCATA / GALVANIZED SHEET METAL

DESCRIZIONE / DESCRIPTION:

OSSARIO A DOPPIA ZEPPA
DOUBLE WEDDING OSSUARY

PT0954

56 x 22 x 27 cm

MATERIALE: LAMIERA ZINCATA / GALVANIZED SHEET METAL

DESCRIZIONE / DESCRIPTION:

OSSARIO A ZEPPA
WEDDING OSSUARY

PT0955

54 x 27 x 24 cm

MATERIALE: LAMIERA ZINCATA / GALVANIZED SHEET METAL

DESCRIZIONE / DESCRIPTION:

OSSARIO AD INCASTRO
JOINT OSSUARY

conf. 10 pz

PT1000

PT1001

DESCRIZIONE / DESCRIPTION:

SALDATORE ORIENTABILE
ORIENTABLE WELDER

bombola + valigia + mazzetta da 300gr

DESCRIZIONE / DESCRIPTION:

SALDATORE
WELDER

tubo + bombola + valigia + mazzetta da 300gr

PT1002

1 Kg

PT1023

DESCRIZIONE / DESCRIPTION:

SALDATORE RICARICABILE
RECHARGABLE WELDER

DESCRIZIONE / DESCRIPTION:

SALDATORE ELETTRONICO
ELECTRONIC WELDER

PT1003

300gr

PT1004

500gr

DESCRIZIONE / DESCRIPTION:

 PUNTA SALDATORE LONG LIFE
 LONG LIFE WELDER TIP

PT1007

DESCRIZIONE / DESCRIPTION:

 UGELLI CON FILTRO
 FILTERED NOZZLE

PT1010

1 Kg

DESCRIZIONE / DESCRIPTION:

 BOMBOLA RICARICABILE
 RECHARGABLE BOTTLE

PT1011

400 ml

DESCRIZIONE / DESCRIPTION:

 BOMBOLETTE BUTAN/PROPAN
 BUTAN/PROPAN BOTTLE

PT1012

DESCRIZIONE / DESCRIPTION:

VERGHETTA STAGNO 50%

PT1014

250 ml

DESCRIZIONE / DESCRIPTION:

FLACONE VUOTO
EMPTY BOTTLE

PT1029

1 Kg

DESCRIZIONE / DESCRIPTION:

LIQUIDO PER SILDARE

PT1031

100 pz

DESCRIZIONE / DESCRIPTION:

SALVIETTINE SGRASSANTI PER COFANI
CLEANING WIPES

PT1042

28x9x20 cm - 1,2Kg

DESCRIZIONE / DESCRIPTION:

PISTOLA MANUALE PER BICOMPONENTE PT1041
DISPENSING GUN FOR PT1041

PT1043

14,3x2,8 cm

DESCRIZIONE / DESCRIPTION:

BECCUCCIO MIXER PER PT1041
NOZZLE FOR PT1041

PT1041

200 ml

DESCRIZIONE / DESCRIPTION:

SIGILLANTE BICOMPONENTE A FREDDO
COFFIN COLD SEALANT BI-COMPONENT

PT1037

pistola + batteria + caricabatterie + borsa.

DESCRIZIONE / DESCRIPTION:

PISTOLA ELETTRICA A BATTERIA PER PT1030/M
BATTERY-POWERED ELECTRIC GUN

PT0998

Portata h:75 kg - v:35Kg - diametro: 12 cm

DESCRIZIONE / DESCRIPTION:

VENTOSE DI SOLLEVAMENTO
SUCTION CUPS FOR LIFTING

PT1030/M

300 ml - **necessita di pistola erogatrice**

DESCRIZIONE / DESCRIPTION:

SIGILLANTE A FREDDO PER COFANI
COFFIN COLD SEALANT

PT1038

33mt - larghezza nastro: 19 mm - spessore 1,1 mm

DESCRIZIONE / DESCRIPTION:

NASTRO BIADESIVO STRUTTURALE
STRUCTURAL DOUBLE-SIDED TAPE

PT1051

CANDELA A LED / LED CANDLE

DESCRIZIONE / DESCRIPTION:

PT1051/M: vera cera / real wax - h.9cm
PT1051/L: vera cera / real wax - h.13cm
PT1051/XL: vera cera / real wax - h.18cm

PT5060

PT5060ORL

PT5061

MATERIALE: METALLO / MATERIAL: METAL

DESCRIZIONE / DESCRIPTION:

*CORNICE PORTAFOTO
PHOTO FRAME*

*PT5060/S: 9x13 cm
PT5060/M: 10x15 cm
PT5060/L: 13x18 cm
PT5060ORL/L: 13x18 cm*

MATERIALE: METALLO / MATERIAL: METAL

DESCRIZIONE / DESCRIPTION:

*CORNICE PORTAFOTO
PHOTO FRAME*

*PT5061/S: 9x13 cm
PT5061/M: 10x15 cm
PT5061/L: 13x18 cm*

PT5064

PT5075

MATERIALE: METALLO / MATERIAL: METAL

DESCRIZIONE / DESCRIPTION:

*CORNICE PORTAFOTO
PHOTO FRAME*

*PT5064/S: 9x13 cm
PT5064/M: 10x15 cm*

MATERIALE: METALLO / MATERIAL: METAL

DESCRIZIONE / DESCRIPTION:

*CORNICE PORTAFOTO
PHOTO FRAME*

PT5075/M: 10x15 cm

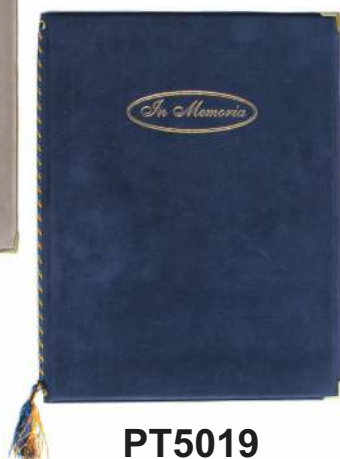
PT5018

PT5019

PT5024 - PT5025
20X27 cm

MATERIALE: FLOCCATO / MATERIAL: FLOCKED

DESCRIZIONE / DESCRIPTION:

**LIBRO FIRMA
SIGNATURE BOOK**

*PT5018: grigio / grey
PT5019: blu / blue*

MATERIALE: CARTA 140gr / MATERIAL: PAPER 140gr

DESCRIZIONE / DESCRIPTION:

**FRONTESPIZIO PIEGATO
FOLDED TITLE PAGE**

*PT5024: senza righe interne / no internal lines
PT5025: righe interne / internal lines*

PT5026/BL-PT5027/BL

PT5026/MA-PT5027/MA

MATERIALE: CARTA / MATERIAL: PAPER

DESCRIZIONE / DESCRIPTION:

**LIBRO FIRMA
SIGNATURE BOOK**

*PT5026/BL: busta 22x32cm 170gr - BLU
PT5027/BL: album firma 20x27cm 170gr - BLU
PT5026/MA: busta 22x32cm 170gr - MARRONE
PT5027/MA: album firma 20x27cm 170gr - MARRONE*

PT5001

8mm
legno/wood
marrone chiaro/light brown

PT5004

6mm
legno/wood
rosso/red
profumato/scented

PT5005

8mm
legno/wood
marrone/brown

PT5006

6mm
vetro/glass
grigio/grey

PT5007

6mm
vetro/glass
rosa/pink



PT5008

6mm
vetro/glass
bianco/white



PT5012

6mm
ematite/hematite
nero/black



PT5013

6mm
legno/wood
nero/black



PT5014

4mm
legno/wood
marrone/brown
corda/cord



NOTE / NOTES



ZORSOL

SINCE 1943



ZORSOL srl

Strada Provinciale 27 N.2 - 26842 Cornovecchio (LO)

Tel.+39.0377.70.98.50

info: commerciale@zorsol.it | www.zorsol.com